

Product Parts for HARDWARE (STEPS 1 THRU 5)

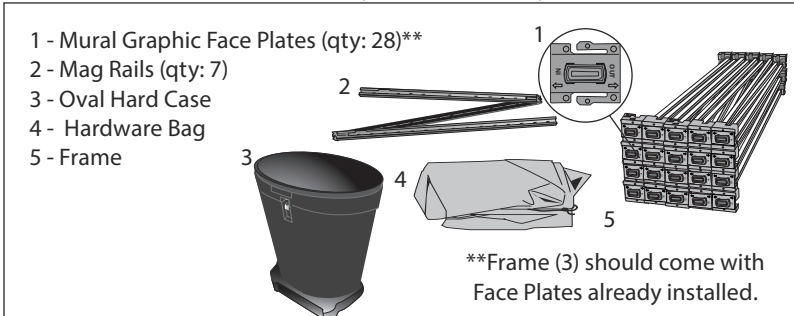

Product Parts for PANEL KITS and LIGHTS

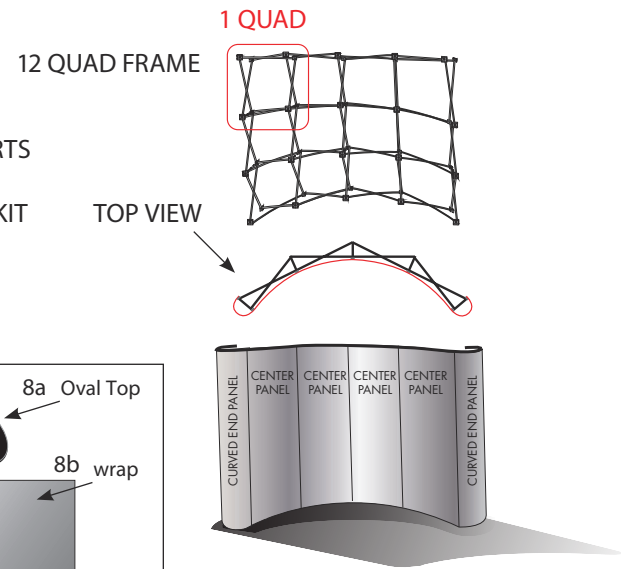
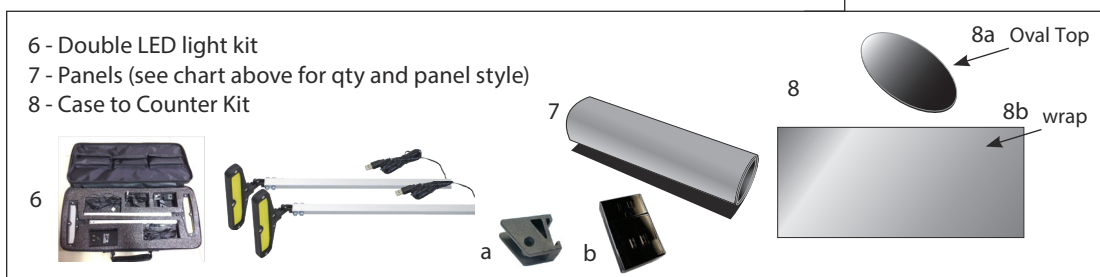

Display Set-Up

Step 1

Remove all parts from your Hard Case (3) and place on a flat, clean surface. Review the Frame (5) and notice where the pivoting light clips are located. This will determine the TOP of the display.

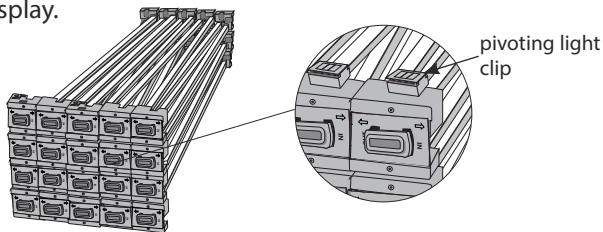

Step 3

Push all locking clips together to secure the Frame (5) in its expanded position.

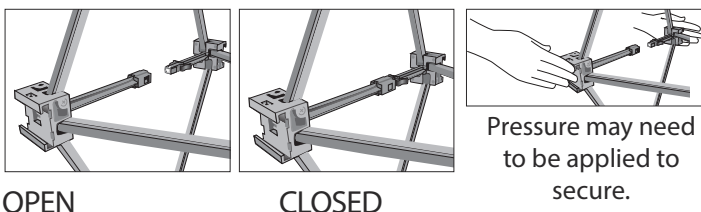

Step 2

Pull the Frame (5) up and out from the corners until it is fully expanded on the floor.

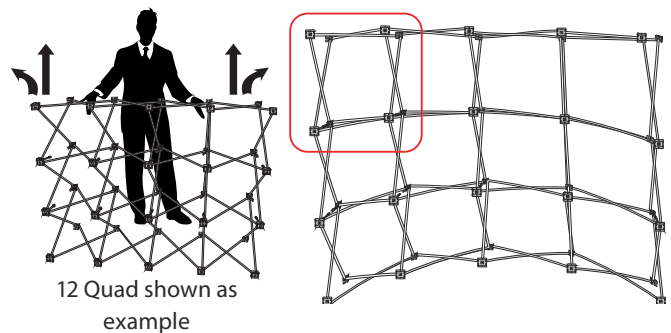

Step 4

With Frame (5) set up and in locked position, you will now be installing all of the Mag Rails (2). Steps 5 thru 9 show how to install the Mag Rails (2) as well as an instructional video:

http://creativedisplaysite.com/Mag_Rail_Install.html

Display Set-Up Continued

Step 5:

With 3-sectioned Mag Rail (2) folded, (fold so pins are UP and facing away from the frame) start with BOTTOM section and slide back slot onto Mural Graphic Face Plates (1) on Frame.

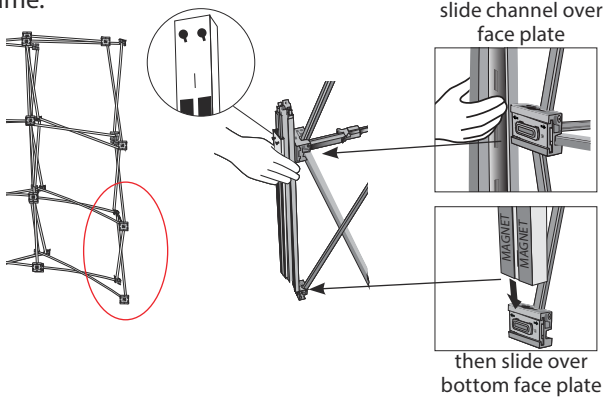

Step 6:

Unfold Mag Rail (2) and fold TOP section onto MIDDLE section. (pins will now be facing the magnets on the middle section)

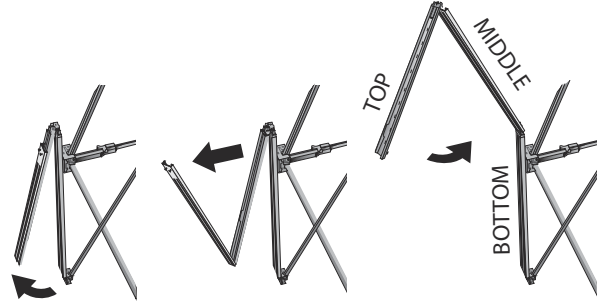

Step 7:

Slide MIDDLE section onto the next upper hub, then interlock to bottom section.

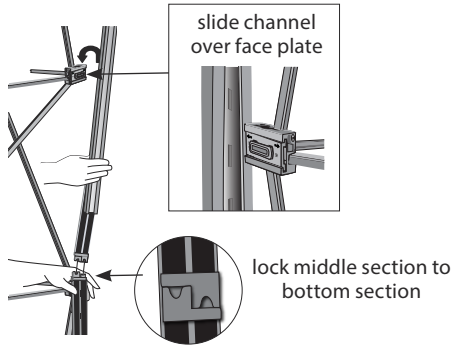

Step 8:

Repeat to secure TOP section of Mag Rail (2) to Frame.

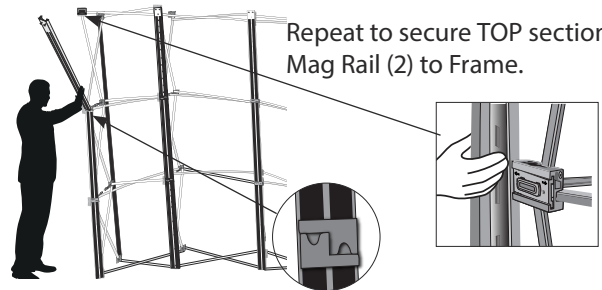

Step 9:

Connect the Mag Rails (2) to the Frame (5) on all front connection points as well as the back vertical ends. Once all Mag Rails (2) are installed give the rails a shake to verify that are all secure.

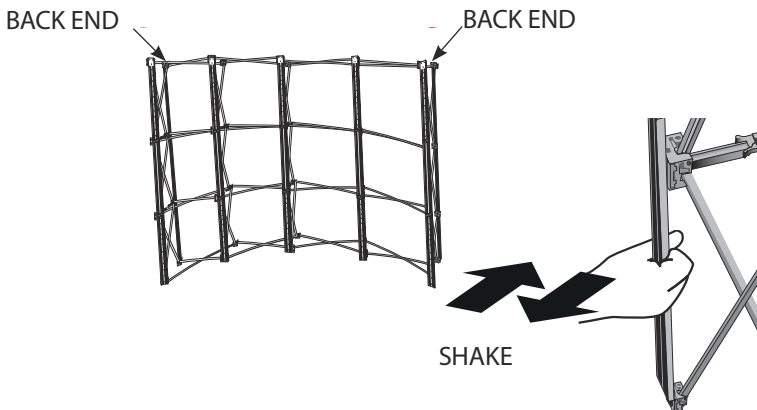

Step 10:

Universal Light Adapter for Pop-Ups

Insert the Light Fixture into the adapter (6a) and align the holes. Insert the quick release pin. Slide the adapter over the light clip on top of the frame.



Display Set-Up Continued...

Step 11:

Set all plastic wrapped panels (7) out on floor in order of how they will be installed. All panels are installed by hooking the notch located on the top of the panel (7) to the pins at the top of the mag rail (2).

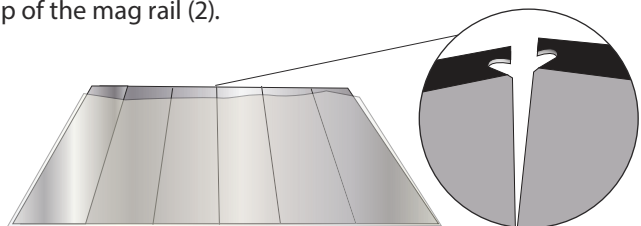

(KEEP the protective sleeves as they will be used for storage.)

Step 12:

Install the Panels (7) to the Frame (5). Start with the end panel. Remove it from protective sleeve, and while holding it in a curved position, hook the notches over the pins at the top of front end and back end Mag Rail. With top notches secure, slide your hands down each side of the curved end panel securing it to the vertical Magnets.

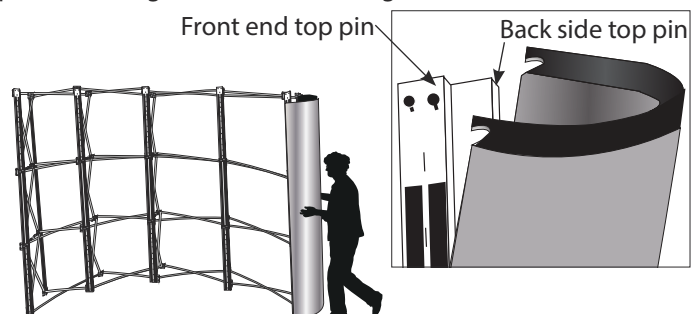

Step 13:

Secure the rest of the panels using the same method as in Step 8.



Step 14:

Plug lights (6) into power source. Display is now ready.

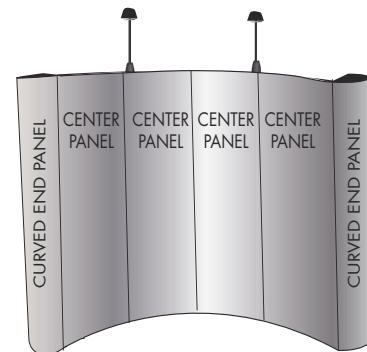

Step 15:

Secure Wrap (8b) to the Oval Case (3). Velcro® connection point will be on the backside of Case (3).

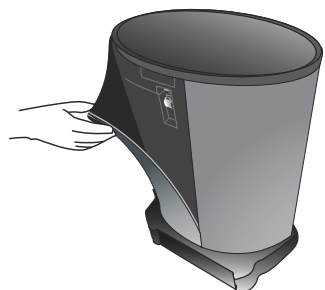

Step 16:

Place the oval Top (8a) part of the Case to Counter Kit (8) in the groove on top of the Oval Case (3)

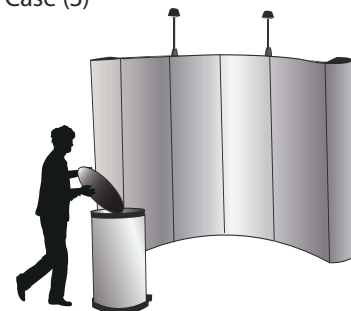

Disassembly Instructions

Step 1

Remove all Panels (7) and carefully roll them up graphic/fabric side out. Place into clear protective sleeves.

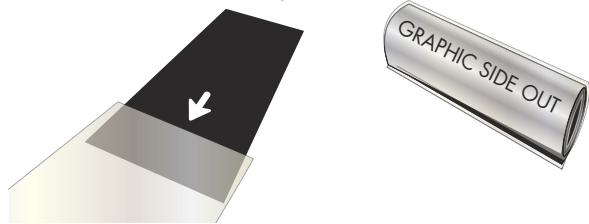

Step 3

Unplug and remove light kit (6) from Frame (5). Place in carrying case.



Step 5

Collapse Frame (5). **MAKE SURE ALL LOCKING CLIPS ARE IN OPEN POSITION** before collapsing Frame (5)

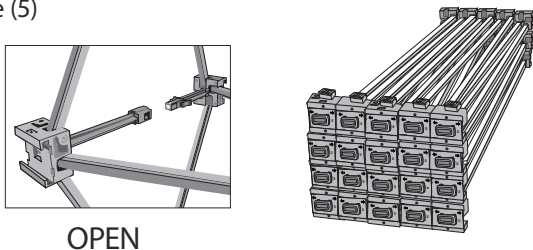

SET-UP NOTE:

Display should have Face Plates (1) already installed in Frame (5). If not, Slide (with force) the Face Plate (1) into the hubs. Typically you will slide **RIGHT to LEFT** when looking at the face of the Frame (4).

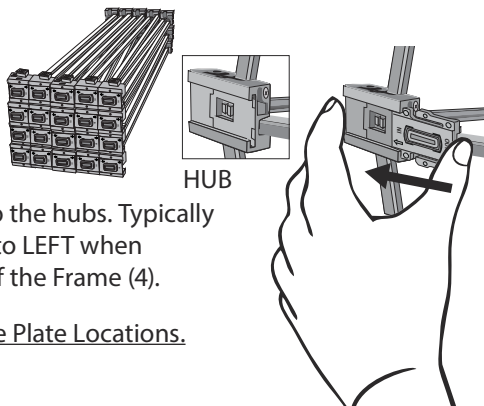

See opposite for Face Plate Locations.

Step 2

Place rolled Panels (7) into Oval Hard Case (3).



Step 4

Remove all Mag Rails (2) from Frame (5). Collapse and place in hardware bag (4)

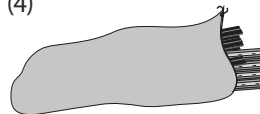

Step 6

Place all parts in the open center area inside the shipping case with rolled Panels (6).

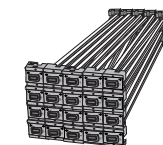
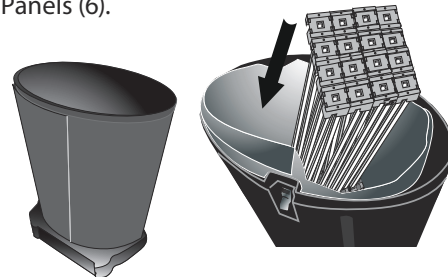

FRONT VIEW
(all hubs)



BACK VIEW
(vertical ends only)

NOTE: FRAME HARDWARE HAS HUBS THAT CAN BE INTERCHANGED TO DISPLAY OTHER PRODUCTS
Conversion kits sold separately-contact client services for more details