

# Formulate 20'x 20' Island Exhibit - Kit 10

## CFAB-K-10

Formulate® Fusion provides an unparalleled dynamic that elevates and accentuates a message and brand, but also maximizes the return on tradeshow investment. Formulate Fusion is Origin's collection of 20ft x 20ft exhibit kits and custom solutions. A fusion of FORM, FABRIC and FUNCTION, these kits combine organic and architectural shapes with state-of-the-art zipper pillowcase dye-sublimated fabric graphics to create unique, dynamic and functional island space.



## features and benefits:

- 30mm aluminum tube frame
- Single-sided SEG dye-sublimated fabric graphics
- Kit includes frame, dye-sublimated graphics and eight medium monitor mounts.
- Kit includes: medium monitor mounts, can hold 32-55" monitor / max weight 80lbs
- Lifetime hardware warranty against manufacturer defects

## dimensions:

### Hardware

### Assembled unit:

195.75" w x 150.75" h x 177.65" d  
4969mm(w) x 3829mm(h) x 4510mm(d)

### Approximate weight with cases:

1339 lbs / 607 kgs

### Shipping

#### Packing case(s):

1 WOODCRATE-H  
1 FS-WOODCRATE

#### Shipping Dimensions:

WOODCRATE-H:  
101"l x 53"h x 31"d  
2565mm(l) x 1347mm(h) x 788mm(d)

#### FS-WOODCRATE:

90"l x 33"h x 30"d  
2286mm(l) x 839mm(h) x 762mm(d)

#### Approximate total shipping weight

(includes cases & graphics):  
1544 lbs / 700 kgs

### Graphic

Refer to related graphic template for more information.

#### Visit:

[www.exhibitors-handbook.com/graphic-templates](http://www.exhibitors-handbook.com/graphic-templates)

## additional information:

Graphic material:  
dye-sublimation zipper pillowcase fabric

\*Monitors and flooring not included

#### Wood Finish Options



silver black mahogany natural

#### 4 person assembly recommended:



We are continually improving and modifying our product range and reserve the right to vary the specifications without prior notice. All dimensions and weights quoted are approximate and we accept no responsibility for variance. E&OE. See Graphic Templates for graphic bleed specifications.

# Included In Your Kit

STRUCTURES



TOWER-03 x4



C-WALL x1



W-01-C x1



RNDSQU-1606 x1

# Suggested Kit Layout

CFAB-K-10

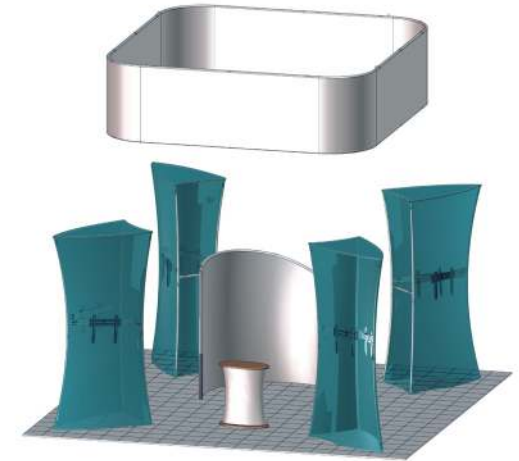
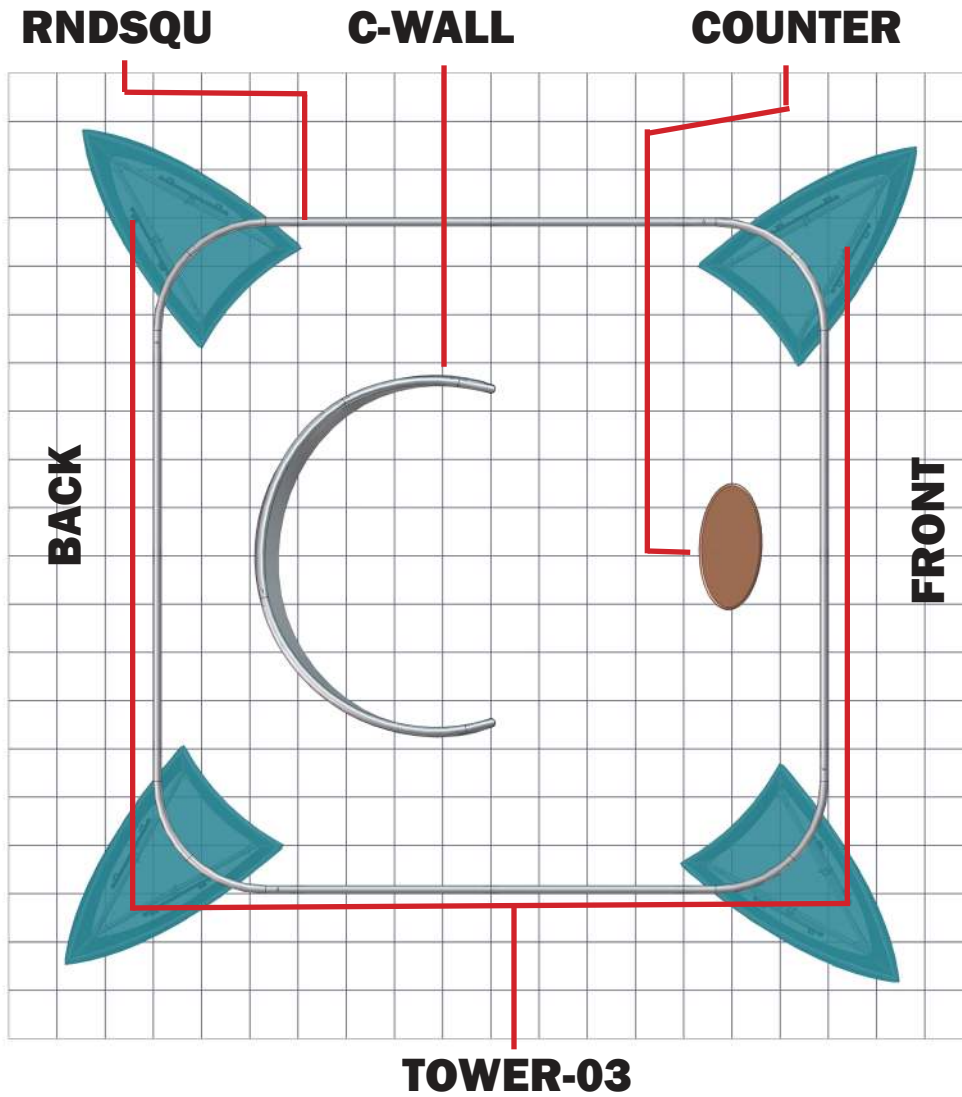

**FRONT**

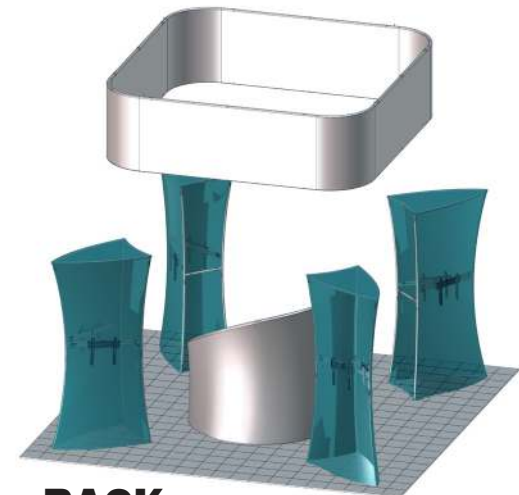

**BACK**

# Formulate Tower - 03

## TOWER-03

When you are looking for a way to draw attention and captivate your audience at a tradeshow, special event, or in a permanent environment, these Formulate® tension fabric architectural structures are designed to impress. Mix and match the Formulate line of towers to add architecture and drama to any event or interior space. Cylinder, Rectangular and Shield-shaped towers come in 12', 10' and 8' heights and 3' square / diameters at the tops and bottoms.

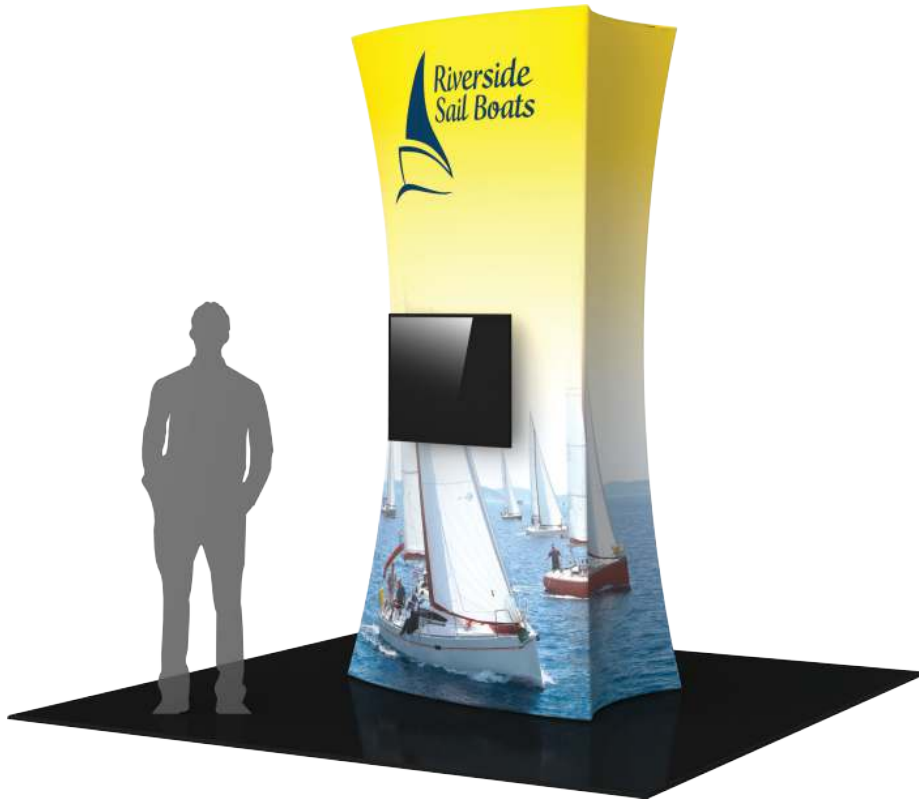

## features and benefits:

- Premium aluminum tube frames with spigot and snap button assembly
- Easy to store and ship
- Quick to set up
- Lifetime limited hardware warranty against manufacturer defects

- One zipper pillowcase fabric graphic
- Kit includes:
  - (2) medium monitor mounts,
  - can hold 32-55" monitor/ max weight 15 lbs

## dimensions:

### Hardware

Assembled unit:  
60.15" w x 120" h x 36" d  
1528mm(w) x 3048mm(h) x 914mm(d)

Approximate weight with cases:  
119 lbs / 54gs

### Graphic

Refer to related graphic template for more information.

Visit:  
[www.exhibitors-handbook.com/graphic-templates](http://www.exhibitors-handbook.com/graphic-templates)

### Shipping

Packing case(s):  
1 OCE Case  
1 OCH Case

Shipping dimensions:  
OCE: Expandable case length (l) may vary  
40"-66" l x 18" h x 18" d  
1016mm-1676mm(l) x 457mm(h) x 457mm(d)

OCH:  
50" l x 29" h x 12" d  
1270mm(l) x 737mm(h) x 305mm(d)

Approximate total shipping weight  
(includes cases & graphics):  
137 lbs / 62kgs

## additional information:

Graphic material:  
dye-sublimation zipper pillowcase fabric

\*Monitors not included

When included in a larger kit, a different packaging so accommodate all contents of the kit.  
Individual packaging no longer provided.

2 person assembly recommended:



We are continually improving and modifying our product range and reserve the right to vary the specifications without prior notice. All dimensions and weights quoted are approximate and we accept no responsibility for variance. E&OE. See Graphic Templates for graphic bleed specifications.

# Included In Your Kit

Tools, Components,  
& Connectors



ALLEN KEY SET x1



ES30 x40



TUBE-M-MB x2

Graphics

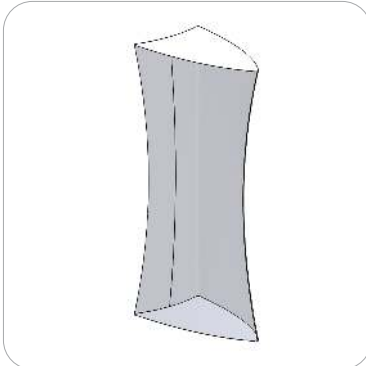

TOWER-03-G x1

# Included In Your Kit



TOWER-02-T1 x2



TOWER-02-T2 x2



TOWER-02-T3 x2



TOWER-02-T4 x2



TOWER-02-T5 x2

Tubes



TOWER-02-T6 x4



TOWER-02-T7 x2



TOWER-02-T8 x2



TOWER-02-T9 x1



TOWER-02-T10 x2



TOWER-02-T11 x1



TOWER-02-T14 x4



TOWER-02-T15 x1



TOWER-02-T16 x1

# Exploded View

**TOWER-03**

**FRAME A**

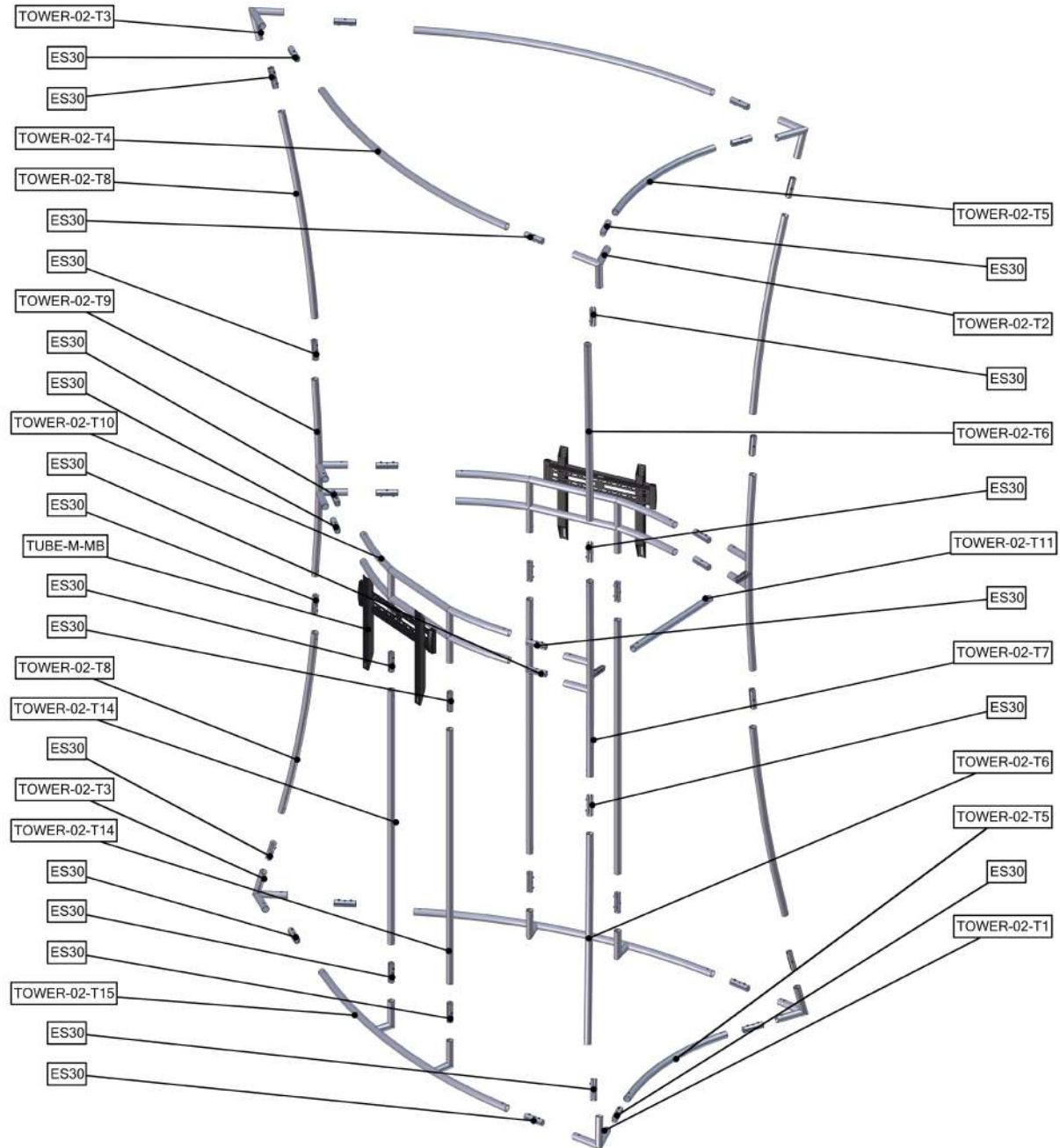

# Labeling Diagram

**TOWER-03**

**FRAME A**

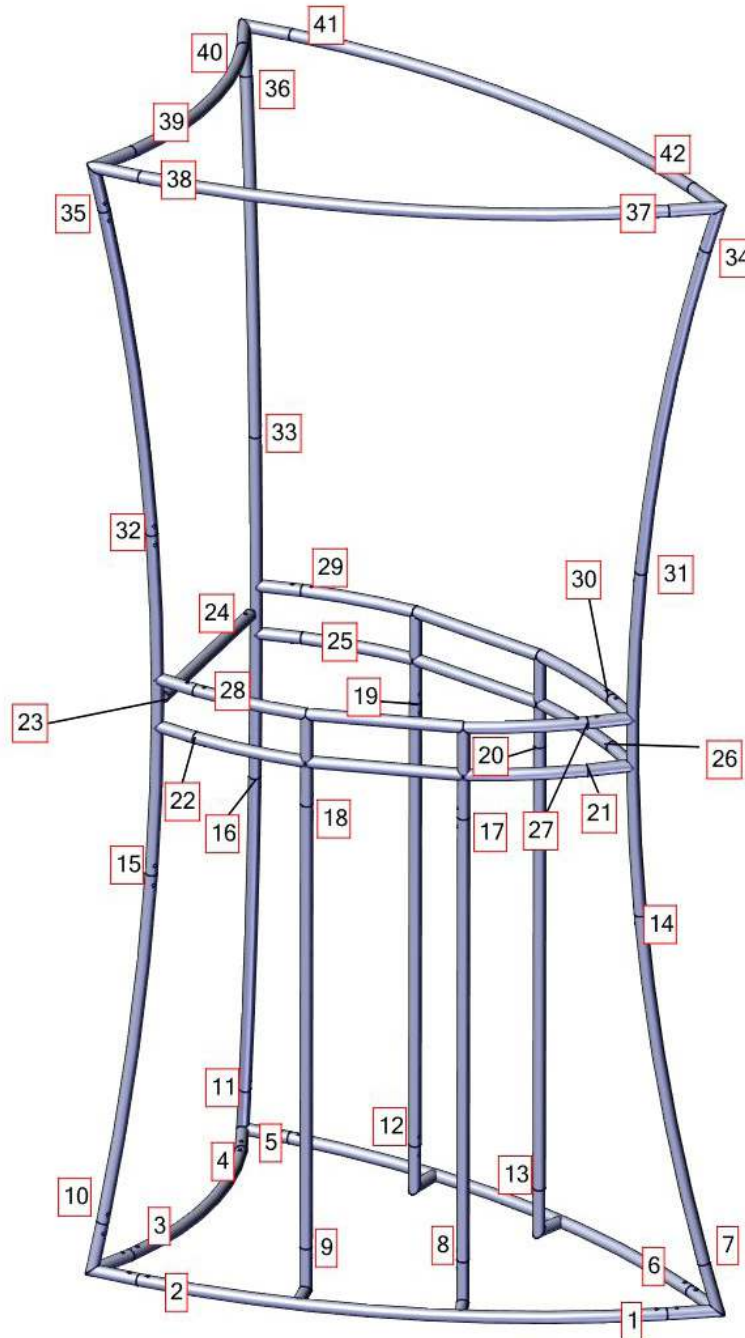



# Connection Methods

Formulate® structures use a number of different yet simple connection methods. Your kit will include one or more of the connection methods shown below. Steps within the Kit Assembly will reference a specific method for each connection point.

## Connection Method 1: ES30 / ES50 / ES75

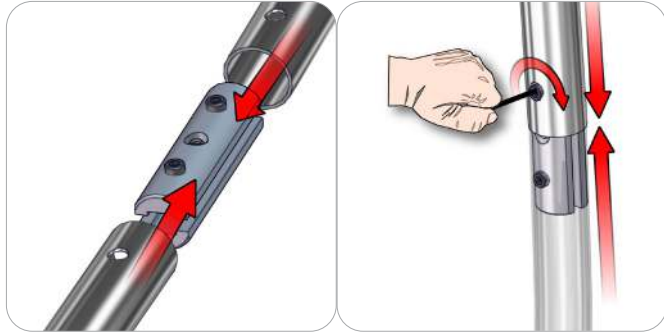

Compress the unlocked connector and slide one tube onto each end. Lock both screws carefully using your allen key tool. Be sure to lock securely, but do not overtighten.

## Connection Method 2: Snap Buttons & Swage

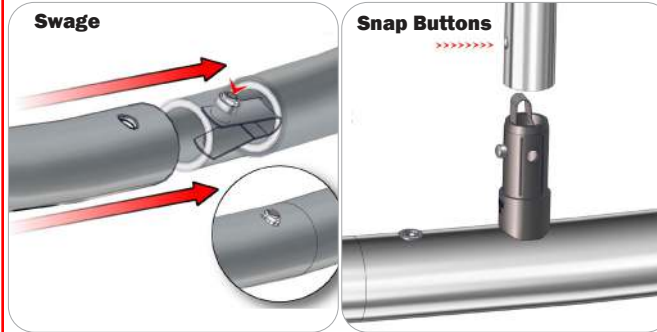

Locate the snap button on the connector or swage tube. Locate the hole on the corresponding tube. Press the snap button with your thumb and slide the tube and connector together so that the snap button snaps fully into the lock hole. To disassemble, press the snap button and pull apart.

## Connection Method 3: ES30-90B / ES30-I / ES30-C



Compress one unlocked end of the connector and slide it through one tube end. Compress the other end of the connector and slide the second tube on. Lock both screws carefully using your allen key tool. Be sure to lock securely, but do not overtighten.

## Connection Method 4: Tube Clamps



Be sure to fully assemble all frames before using clamps. With the clamp unlocked, place one tube of the first frame into the mouth of the clamp. Place the second tube (if applicable) into the second mouth of the clamp. With both frame's tubes in the clamp, be sure to lock securely, but do not overtighten.

# Kit Assembly

## Step by Step

### Step 1.

Gather the components necessary for assembling Frame A. Assemble in the order the Labeling Diagram instructs.

Refer to Connection Methods 1 and 2 for additional information.

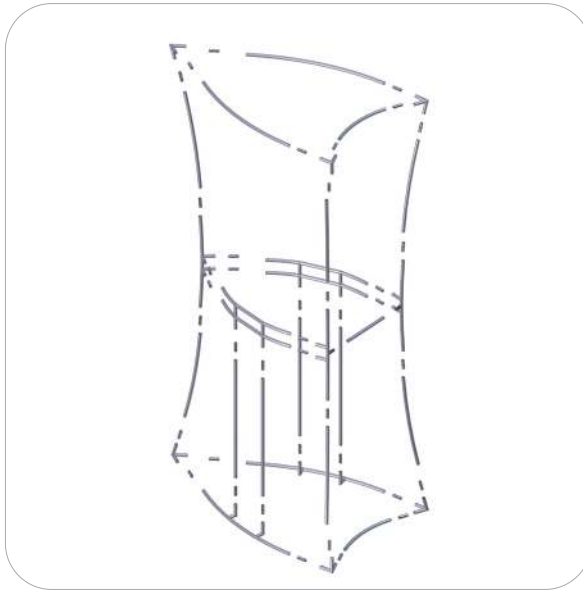

### Step 2.

With the frame laying flat on the floor, locate your pillowcase graphic. With the pillowcase unzipped, encase the frames and zip along the side and bottom.

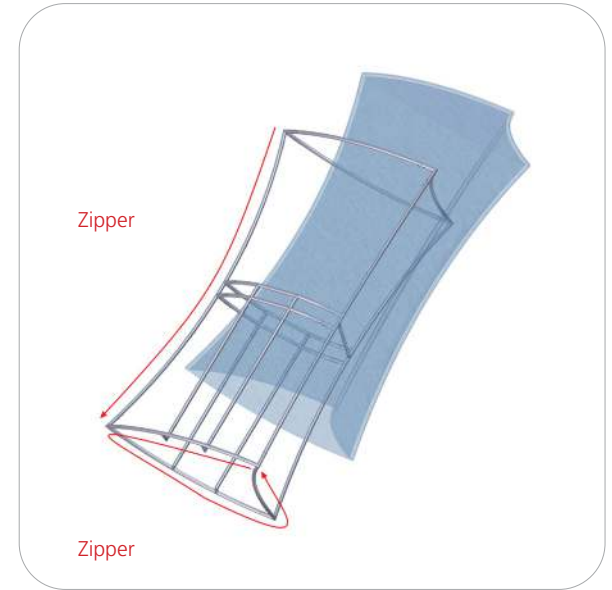
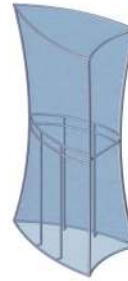

### Step 3.

Attach your monitor mounts through the graphic to the top center tubes of both sides of the frame.

Refer to Connection Method 4 and Monitor Bracket Instruction pages for additional information.



# Formulate C-Shaped Wall

## C-WALL

Formulate® tension fabric conference walls are lightweight, stylish solutions to your meeting space needs. Ergonomically designed, Formulate C-shaped and Serpentine-shaped walls combine the latest developments in fabric printed technology with gently curved 50mm aluminum frames to create private, cozy and stylish conference areas within any space.



## features and benefits:

- State-of-the-art 50mm curved aluminum tube frame with sturdy internal spigots
- Perfect for a small table and chairs or benches for seating
- Create a stylish, semi-private space
- Kit includes: one frame, one dye-sublimated zipper pillowcase graphic, and one wheeled molded OCE storage case
- Lifetime hardware warranty against manufacturer defects

## dimensions:

Hardware	Graphic
<p>Assembled unit: 89.59" w x 84" h x 60" d 2276mm(w) x 2133mm(h) x 1525mm(d)</p> <p>Approximate weight (includes graphic): 42 lbs / 19 kg</p>	<p>Refer to related graphic template for more information.</p> <p>Visit: <a href="http://www.exhibitors-handbook.com/graphic-templates">www.exhibitors-handbook.com/graphic-templates</a></p>
Shipping	
<p>Shipping dimensions: 1 OCE case: 40" up to 66" l x 18" h x 18" d 1016mm up to 1676mm(l) x 457mm(h) x 457mm(d)</p> <p>Approximate shipping weight (with case): 63 lbs / 29 kg</p>	

## additional information:

Graphic material:  
Dye-sublimated zipper pillowcase fabric

We are continually improving and modifying our product range and reserve the right to vary the specifications without prior notice. All dimensions and weights quoted are approximate and we accept no responsibility for variance. E&OE. See Graphic Templates for graphic bleed specifications.

# Included In Your Kit

Tools, Components, & Connectors



ALLEN KEY SET x1



ES30 x3



ES50 x9

Graphics



C-WALL-GDBL x1

# Included In Your Kit

Tubes



C-WALL-T1 x1

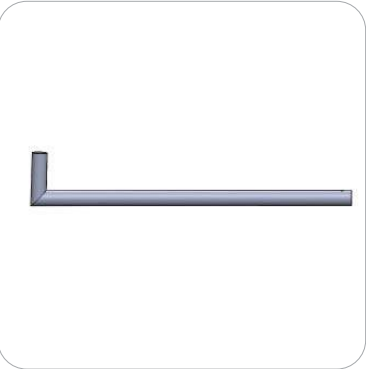

C-WALL-T2 x1

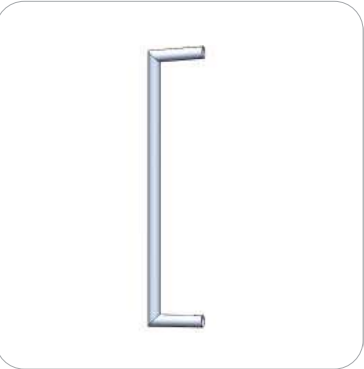

C-WALL-T3 x1



C-WALL-T4 x2



C-WALL-T4-SP x1

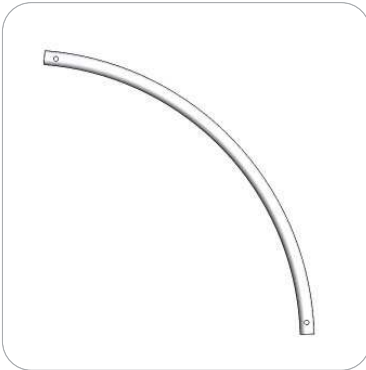

C-WALL-T5 x1



C-WALL-T6 x1



C-WALL-T7 x2



C-WALL-T8 x1

# Exploded View

## C-WALL

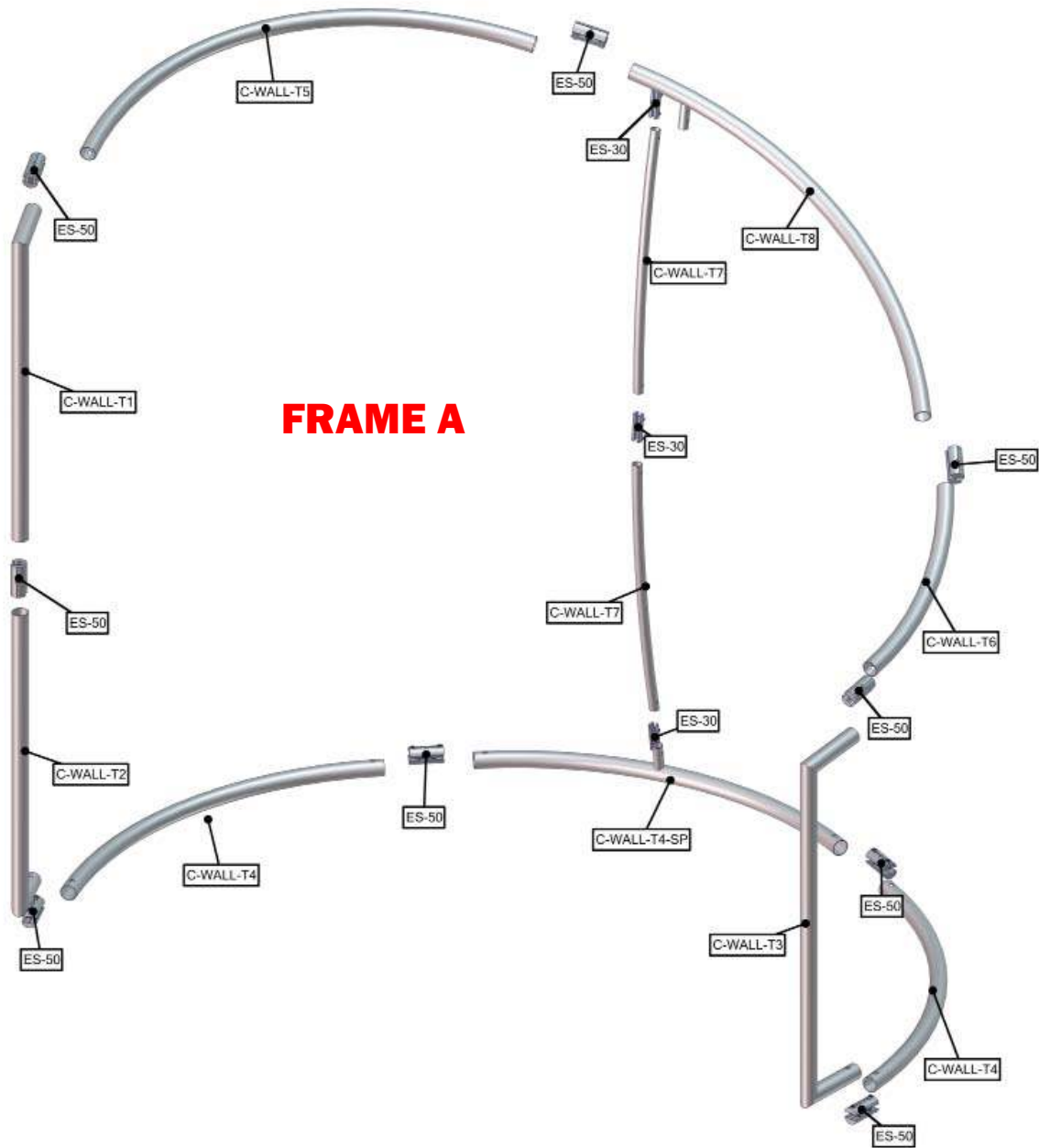

# Labeling Diagram

## C-WALL

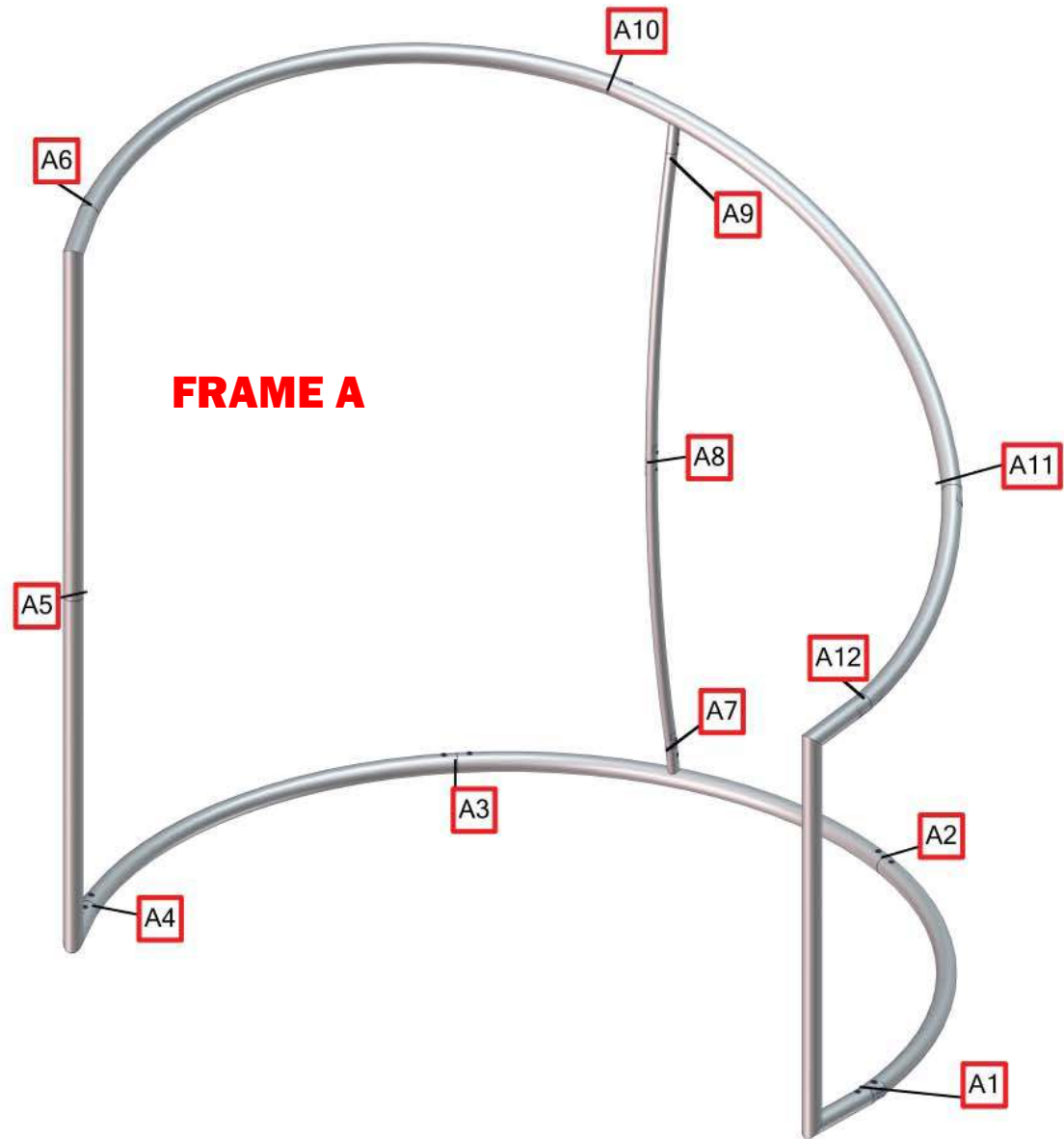

# Connection Methods

Formulate® structures use a number of different yet simple connection methods. Your kit will include one or more of the connection methods shown below. Steps within the Kit Assembly will reference a specific method for each connection point.

## Connection Method 1: ES30 / ES50 / ES75

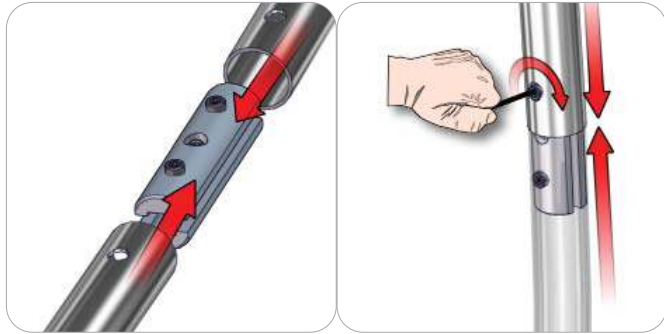

Compress the unlocked connector and slide one tube onto each end. Lock both screws carefully using your allen key tool. Be sure to lock securely, but do not overtighten.

## Connection Method 2: Snap Buttons & Swage

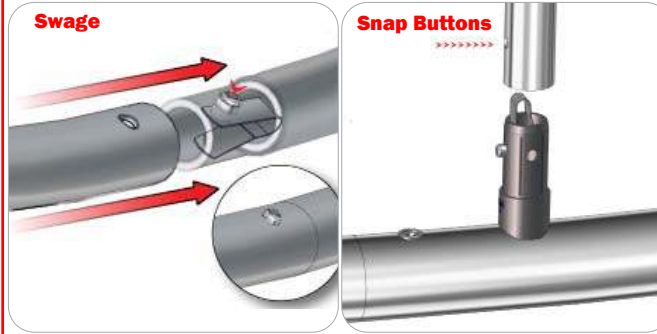

Locate the snap button on the connector or swage tube. Locate the hole on the corresponding tube. Press the snap button with your thumb and slide the tube and connector together so that the snap button snaps fully into the lock hole. To disassemble, press the snap button and pull apart.

## Connection Method 3: ES30-90B / ES30-I / ES30-C



Compress one unlocked end of the connector and slide it through one tube end. Compress the other end of the connector and slide the second tube on. Lock both screws carefully using your allen key tool. Be sure to lock securely, but do not overtighten.

## Connection Method 4: Tube Clamps



Be sure to fully assemble all frames before using clamps. With the clamp unlocked, place one tube of the first frame into the mouth of the clamp. Place the second tube (if applicable) into the second mouth of the clamp. With both frame's tubes in the clamp, be sure to lock securely, but do not overtighten.



# Kit Assembly

## Step by Step

### Step 1.

Gather the components necessary for assembling the frame and lay them flat on the floor. Assemble in the order the Labeling Diagram instructs.

Please reference Connection Methods 1 for more details.

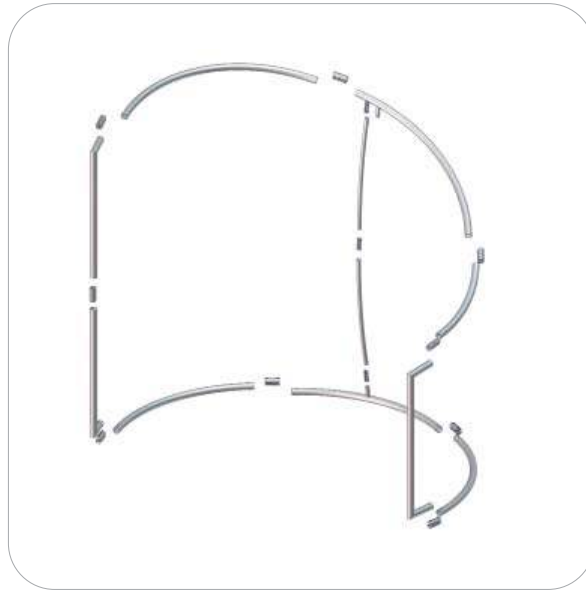

### Step 2.

With the frame laying flat on the floor, locate your pillowcase graphic. With the pillowcase unzipped, encase the frame by covering the frame from top to bottom.



# Formulate Counter - Pillar

## W-01-C

Formulate® counters couple lightweight hardware with printed stretch silicone edge fabric graphics (SEG) to create funky and functional reception stands. Tables and bases are available in four colored finishes – silver, black, mahogany and natural. Custom sizes also available.



## features and benefits:

- Printed stretch silicone edge fabric graphics (SEG) for a custom look
- Counter supports 25 lbs. of weight on center
- Choice of four finishes for table and base
- Kit includes: frame, dye-sublimated fabric graphic, top and base, and wheeled molded OCH2 storage case
- Lifetime hardware warranty against manufacturer defects

## dimensions:

### Hardware

Assembled unit:  
31.5" w x 38" h x 15.75" d  
800mm(w) x 970mm(h) x 400mm(d)

Approximate kit weight (includes graphic):  
28 lbs / 13 kgs

### Shipping

1 OCH2

Shipping dimensions:  
50" l x 30" h x 15" d  
1270mm(l) x 762mm(h) x 381mm(d)

Approximate shipping weight: (kit and case) 58 lbs / 27 kgs

### Graphic

Refer to related graphic template for more information.

Visit:  
[www.exhibitors-handbook.com/graphic-templates](http://www.exhibitors-handbook.com/graphic-templates)



[www.display-setup-animations.com](http://www.display-setup-animations.com)

## additional information:

Graphic material:  
Dye-sublimated fabric

Top/Base finishes:



silver

black

mahogany

natural

1 person assembly recommended:



We are continually improving and modifying our product range and reserve the right to vary the specifications without prior notice. All dimensions and weights quoted are approximate and we accept no responsibility for variance. E&OE. See Graphic Templates for graphic bleed specifications.

# Included In Your Kit

Tools, Components, & Connectors



ALLEN KEY SET x1



TRI30-COUNTER x1



W-01-C-TOP x1



W-01-C-BASE x1

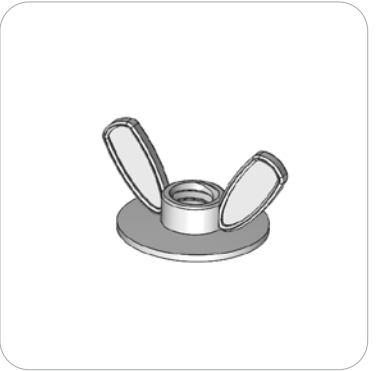

Wing Nut x6



1.25" Stud x3



2" Stud x3

Graphics



W-01-C-FAB1 x1

# Exploded View

W-01-C



# Connection Methods

Formulate® structures use a number of different yet simple connection methods. Your kit will include one or more of the connection methods shown below. Steps within the Kit Assembly will reference a specific method for each connection point.

## Connection Method 1: ES30 / ES50 / ES75

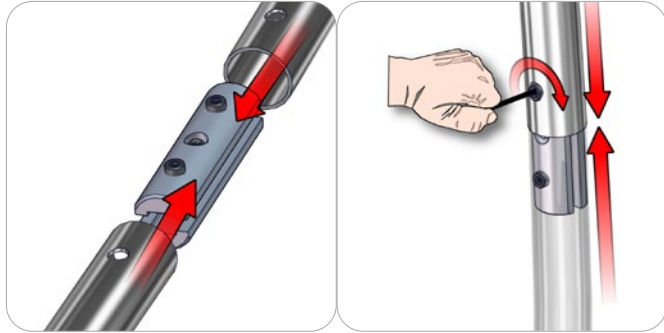

Compress the unlocked connector and slide one tube onto each end. Lock both screws carefully using your allen key tool. Be sure to lock securely, but do not overtighten.

## Connection Method 2: Snap Buttons & Swage

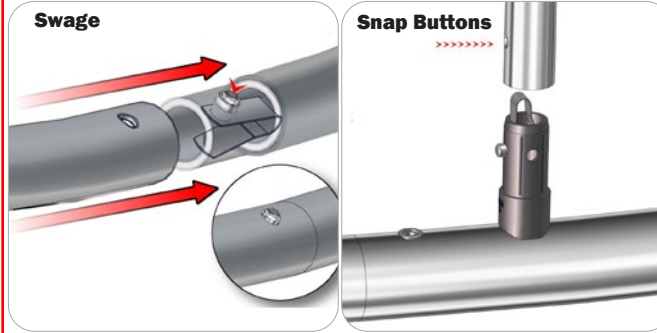

Locate the snap button on the connector or swage tube. Locate the hole on the corresponding tube. Press the snap button with your thumb and slide the tube and connector together so that the snap button snaps fully into the lock hole. To disassemble, press the snap button and pull apart.

## Connection Method 3: ES30-90B / ES30-I / ES30-C

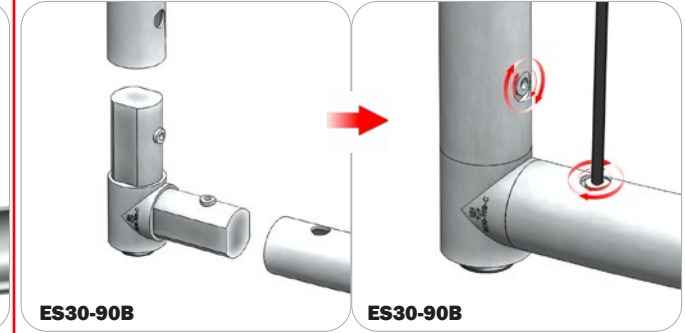

Compress one unlocked end of the connector and slide it through one tube end. Compress the other end of the connector and slide the second tube on. Lock both screws carefully using your allen key tool. Be sure to lock securely, but do not overtighten.

## Connection Method 4: Tube Clamps

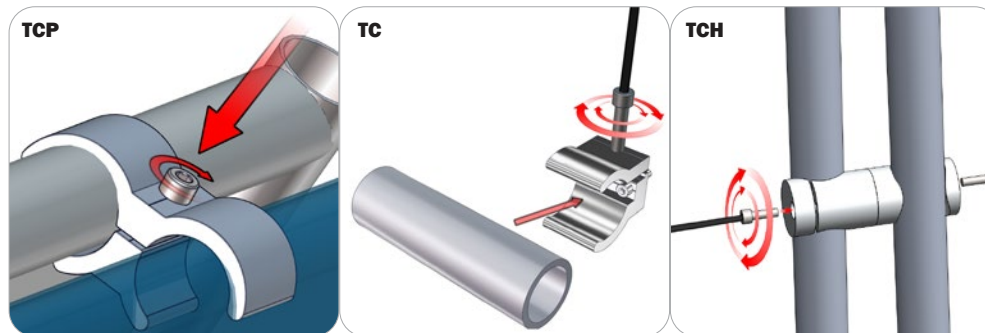

Be sure to fully assemble all frames before using clamps. With the clamp unlocked, place one tube of the first frame into the mouth of the clamp. Place the second tube (if applicable) into the second mouth of the clamp. With both frame's tubes in the clamp, be sure to lock securely, but do not overtighten.

# Kit Assembly

## Step by Step

### Step 1.

Begin by threading your 2" studs through the holes of the base. Attach your TRI30-COUNTER support beam and secure using (3) wingnuts.



### Step 2.

Pull your graphic over TRI30-COUNTER beam and push the edges into the seams of the base.



### Step 3.

Thread the 1.25" studs into the counter top. Align the counter top so that the studs fall through the holes of the TRI30-COUNTER beam. Secure the counter top using the remaining (3) wingnuts.

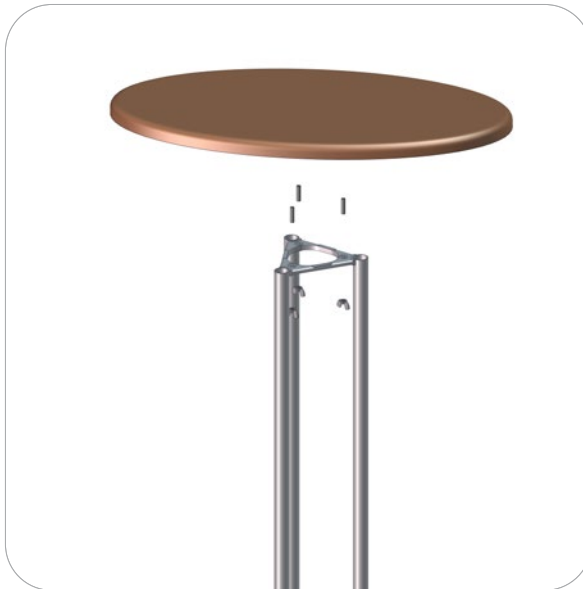

Push the top edges of the graphic into the seams of the counter top to complete your assembly.

Setup Complete.



# Formulate Master 3D Hanging Structures: Rounded Square

## RNDSQU

Formulate® tension fabric hanging structures are made in the USA and are of the utmost quality and durability. Formulate combines state-of-the-art zipper pillowcase dye-sublimated stretch fabric coverings with advanced, lightweight aluminum structures to provide unique design, functionality, and style.



We are continually improving and modifying our product range and reserve the right to vary the specifications without prior notice. All dimensions and weights quoted are approximate and we accept no responsibility for variance. E&OE. See Graphic Templates for graphic bleed specifications.

## features and benefits:

- Four sided hanging structures come in varying heights of 2', 3', 4', 5' & 6'
- Shapes 12' wide and under are constructed with 30mm (1.25") tubes and push button connectors for simple assembly
- Shapes 14' and over are constructed with 50mm (2") tubes and internal expanding spigot connectors for unmatched structural integrity
- Easy to store and ship
- Quick to set up
- One zipper pillowcase fabric graphic
- Lifetime limited hardware warranty against manufacturer defects

## dimensions:

### Hardware

### Assembled unit:

(8', 10', 12', 14', 16', 18' or 20')w x (2', 3', 4', 5', or 6')h

(2.44, 3.05, 3.66, 4.27, 4.88, 5.49, or 6.1)m(w) x (.61, .91, 1.22, 1.52, or 1.83)m(h)

### Approximate weight:

Depending on size, weight varies between:

36lbs/17kgs - 203lbs/92kgs

### Shipping

#### Packing case(s):

1-3 expandable cardboard boxes depending on size

#### Shipping dimensions:

Expandable cardboard box length (l) may vary

45-98"l x 16"h x 16"d

1143-2490mm(l) x 407mm(h) x 407mm(d)

#### Approximate total shipping weight

(includes cases & graphics):

Depending on size, weight varies between:

44lbs/20kgs - 241lbs/110kgs

### Graphic

Refer to related graphic template for more information.

#### Visit:

[www.exhibitors-handbook.com/graphic-templates](http://www.exhibitors-handbook.com/graphic-templates)

## additional information:

### Graphic material:

dye-sublimation zipper pillowcase fabric

### 3 person assembly recommended:



# Included In Your Kit

Tubes, Components & Connectors



EYEBOLT x8

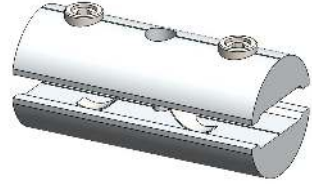

ES50 x24



RNDSQU-16-T1 x8



RNDSQU-16-T2 x8



RNDSQU-16-T3 x8



RNDSQU-16-T4 x8



SPDR-30-S2-6 x24

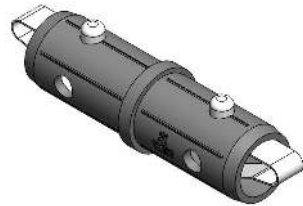

TC-30-S x12

Graphics



RNDSQU-1606-G x1



# Exploded View

RNDSQU-1606

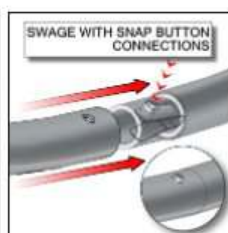
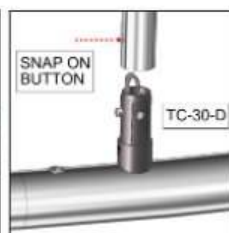
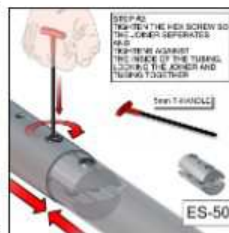
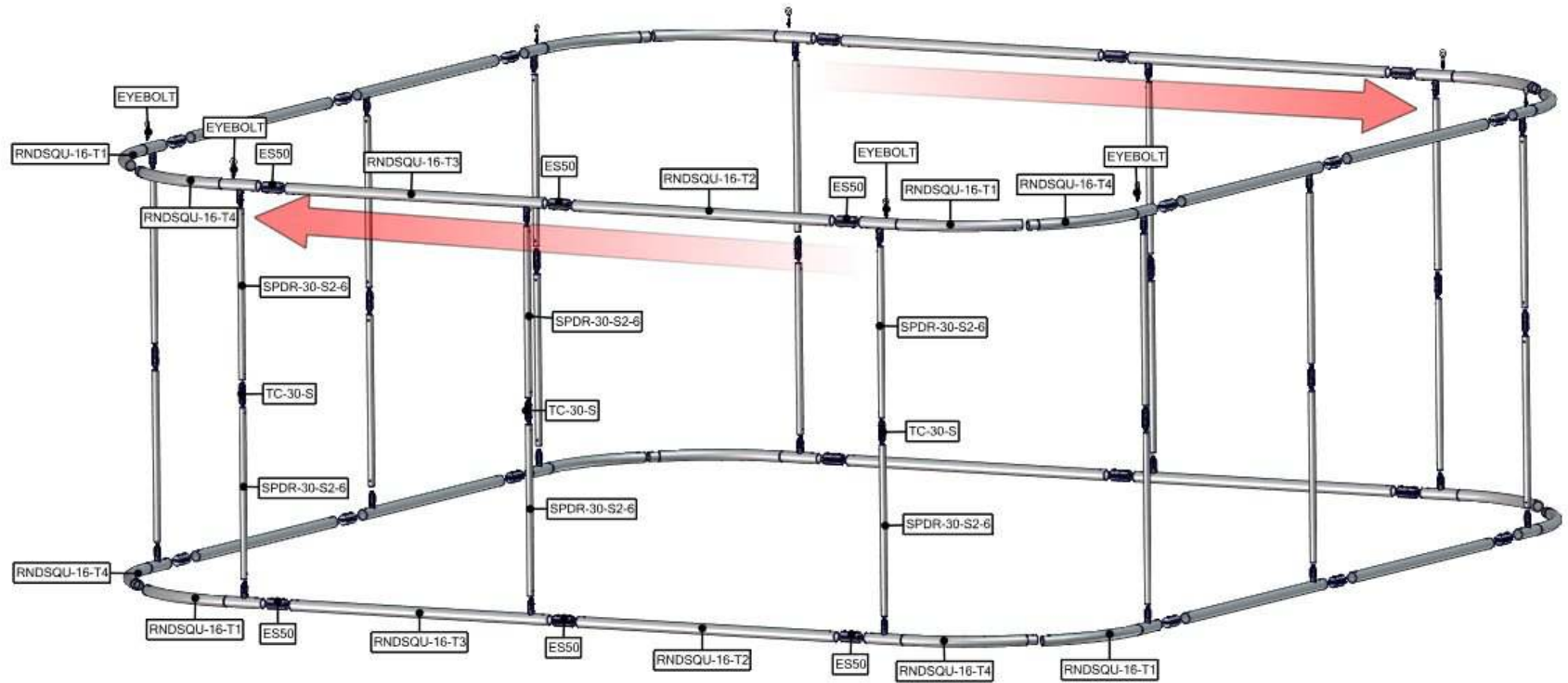

# Labeling Diagram

RNDSQU-1606

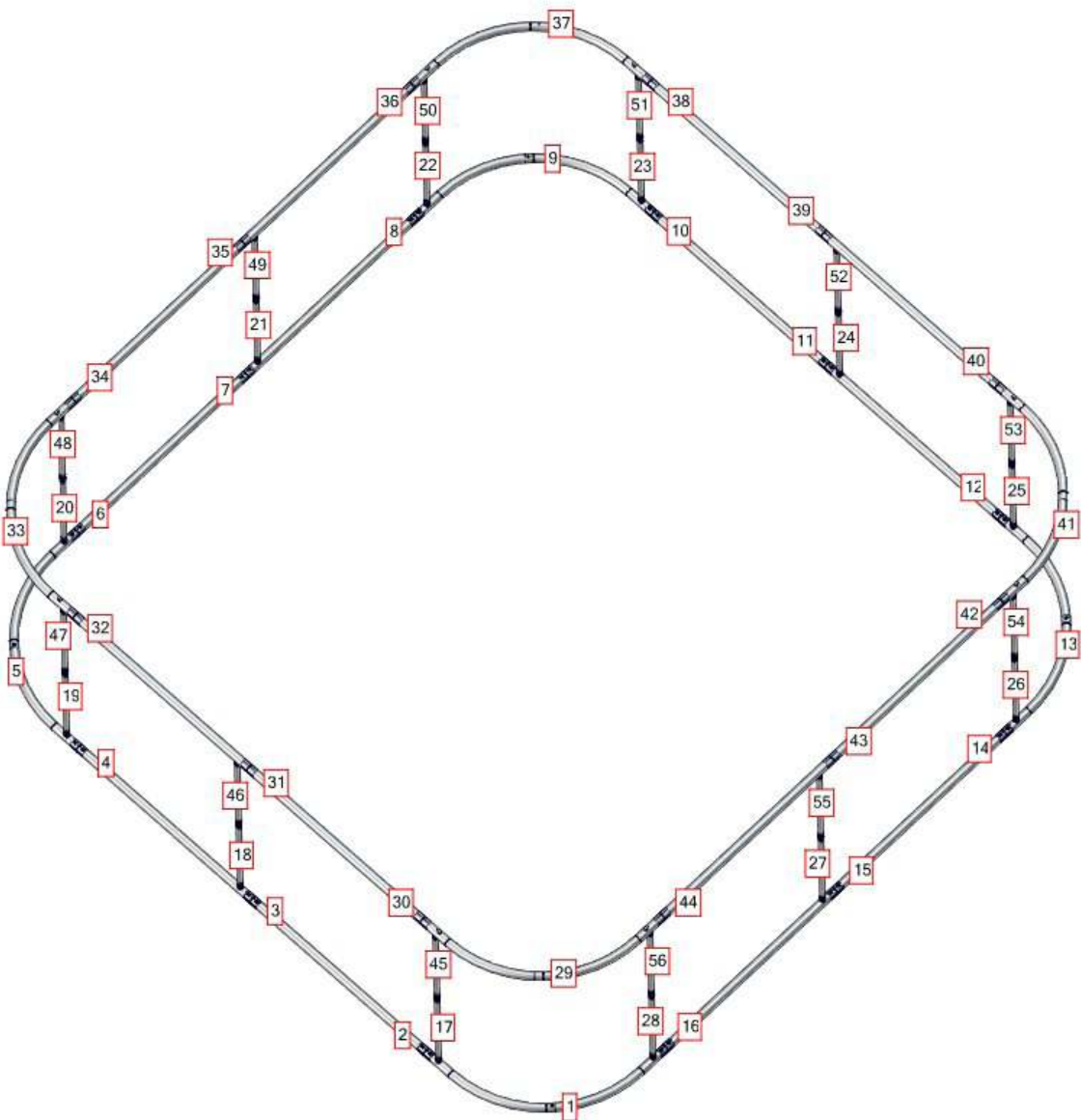

# Connection Methods

Formulate® structures use a number of different yet simple connection methods. Your kit will include one or more of the connection methods shown below. Steps within the Kit Assembly will reference a specific method for each connection point.

## Connection Method 1: ES30 / ES50 / ES75

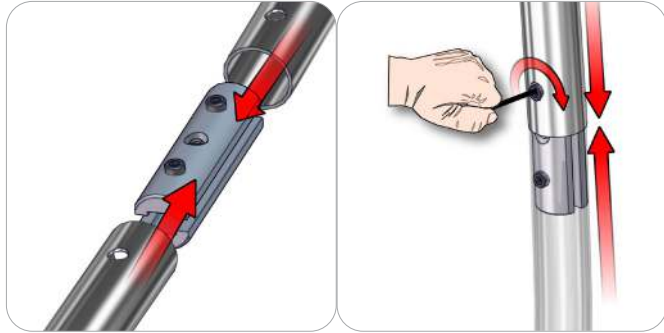

Compress the unlocked connector and slide one tube onto each end. Lock both screws carefully using your allen key tool. Be sure to lock securely, but do not overtighten.

## Connection Method 2: Snap Buttons & Swage

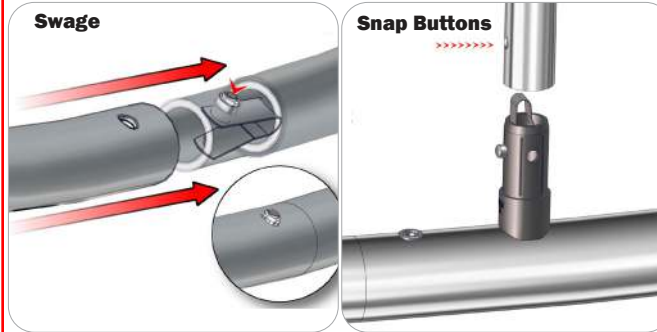

Locate the snap button on the connector or swage tube. Locate the hole on the corresponding tube. Press the snap button with your thumb and slide the tube and connector together so that the snap button snaps fully into the lock hole. To disassemble, press the snap button and pull apart.

## Connection Method 3: ES30-90B / ES30-I / ES30-C



Compress one unlocked end of the connector and slide it through one tube end. Compress the other end of the connector and slide the second tube on. Lock both screws carefully using your allen key tool. Be sure to lock securely, but do not overtighten.

## Connection Method 4: Tube Clamps

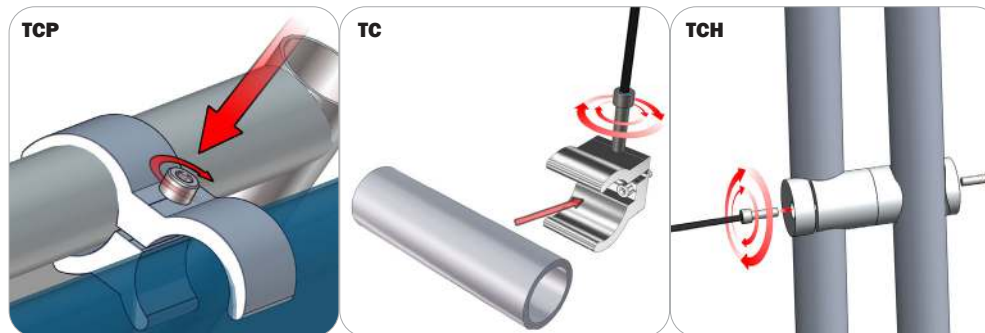

Be sure to fully assemble all frames before using clamps. With the clamp unlocked, place one tube of the first frame into the mouth of the clamp. Place the second tube (if applicable) into the second mouth of the clamp. With both frame's tubes in the clamp, be sure to lock securely, but do not overtighten.

# Kit Assembly

## Step by Step:

### Step 1.

Locate the components necessary for assembling the frame referenced in the exploded view page.

Please reference Connection Methods 1 and 2 for more details.

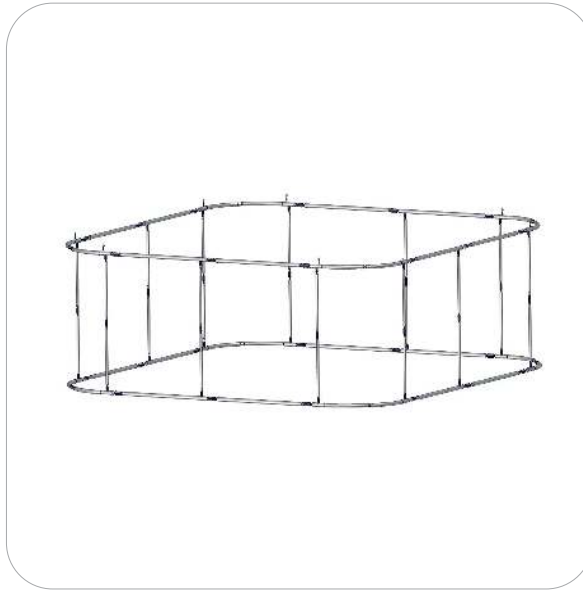
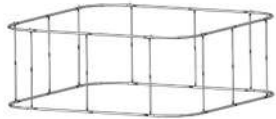

### Step 2.

Apply the graphic pillowcase around the frame from the bottom and then zipper around the top edge.

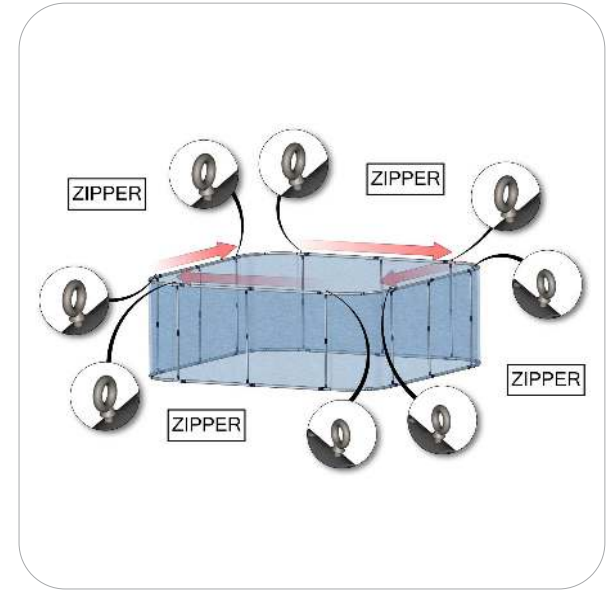
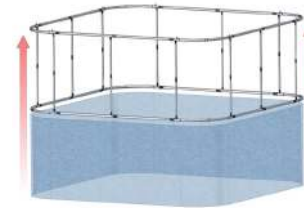

### Step 3.

The structure is now ready to hang.



#### SET UP INSTRUCTIONS:

1. CONNECT BOTTOM AND TOP TUBES FOLLOWING THE LABELS
2. CONNECT SIDE TUBES
3. CLEAN THE FRAME AND PLACE THEM ON CLEAN PLACE
4. CAREFULLY REMOVE FABRIC COVER FROM BAG
5. PLACE COVER AROUND THE BOTTOM OF THE FRAME
6. PULL COVER CAREFULLY UP TO THE TOP
7. CLOSE ALL ZIPPERS
8. ADJUST FABRIC AROUND THE FRAME
9. CONNECT CABLE HARNESS TO THE EYEBOLTS
10. COMPLETELY TIGHTEN THREADED CONNECTORS

#### BREAK DOWN INSTRUCTIONS:

REVERSE SET-UP STEPS TO BREAKDOWN FRAME

#### FABRIC CARE INSTRUCTIONS:

1. UNZIP COVER ZIPPERS
2. CAREFULLY REMOVE FABRIC COVER
3. CLOSE ALL ZIPPERS
4. FOLD OR ROLL NEATLY
5. PLACE FABRIC IN COVER BAG