

# Hybrid Pro Modular Kit 02

## HP-K-02

Hybrid Pro™ Modular exhibits and counters are a perfect solution for the serious exhibitor. Exhibits feature heavy-duty aluminum extrusion frames and push-fit fabric graphics. Count on making an unforgettable impact with Hybrid Pro Modular exhibit kits, counters, and accessories.

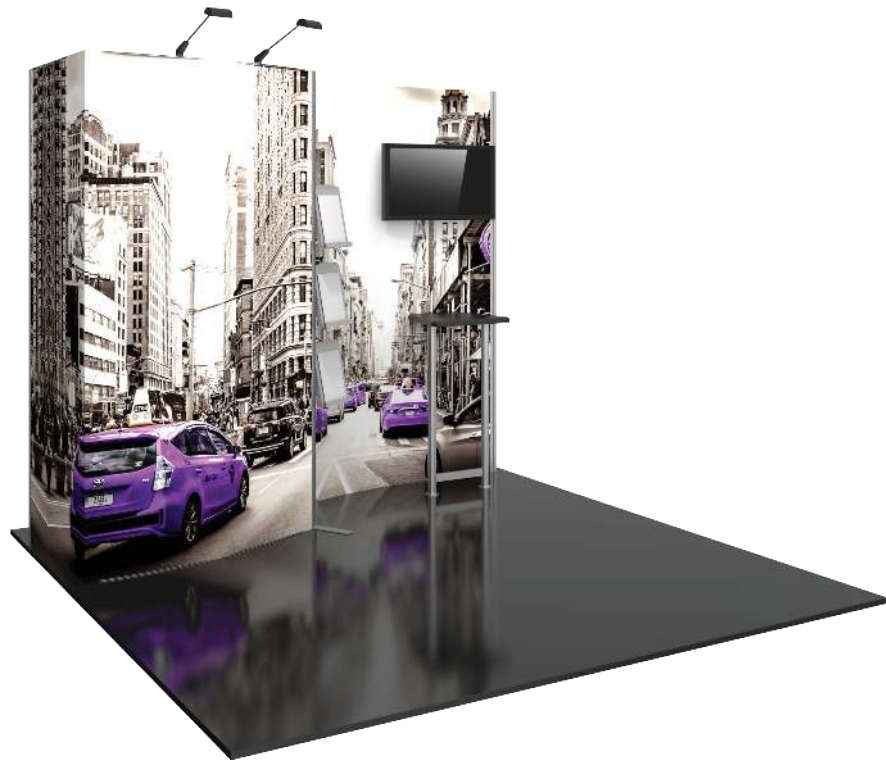

## features and benefits:

- Silver aluminum extrusion frame
  - Single-sided graphics
  - Three literature holders
  - Easy step-by-step instructions
- Kit includes: one frame, three fabric graphic panels, one table, two spotlights, one medium monitor mount\*, three literature holders, and two molded cases
  - Lifetime hardware warranty against manufacturer defects

## dimensions:

### Hardware

Assembled unit:  
115.63" w x 94.5" h x 42.88" d  
2937mm(w) x 2400mm(h) x 1089mm(d)

Approximate weight:  
200 lbs / 91 kg

### Shipping

Packing case(s):  
2 OCH2

Shipping dimensions:  
OCH2:  
52" l x 29" h x 15" d  
1321mm(l) x 737mm(h) x 381mm(d)

Approximate total shipping weight:  
260 lbs / 118 kg

### Graphic

Refer to related graphic template for more information.

Visit:  
[www.exhibitors-handbook.com/graphic-templates](http://www.exhibitors-handbook.com/graphic-templates)

## additional information:

Graphic material:  
Dye-sublimation SEG push-fit fabric

Table dimensions:  
21" w x 40.5" h x 19.7" d  
533mm(w) x 1029mm(h) x 500mm(d)

Table holds max weight 25 lbs / 12 kg

Monitor mount holds max weight: 50 lbs / 37 kg

Monitor mount holds VESA patterns:  
200 x 200 up to 400 x 400mm

\*monitor not included

## Tabletop Colors:

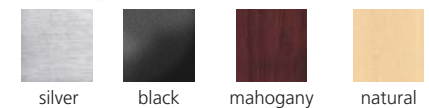

We are continually improving and modifying our product range and reserve the right to vary the specifications without prior notice. All dimensions and weights quoted are approximate and we accept no responsibility for variance. E&OE. See Graphic Templates for graphic bleed specifications.

# Included In Your Kit

Tools, Components, & Connectors



HEX KEY SET x1



PHFC2-1155-L-L1-SIDE x12



PM2R8-1155-A165-L x2



PM2S2-1200-A165 x8



TUBE-30-1155 x2



PHFC2-210-L-L x0



PH4-300-TG x5



PH-300-S-S x1



PH-381-L-L x1



PHFC2-450-L-L1 x2



PHFC2-8R-30-L-L x2



PHFC2-8R-30-L-L1 x2



PHFC2-900-L-L x2

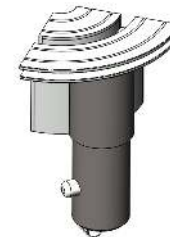

CB10-R x2



CB9-S x12

# Included In Your Kit

Tools, Components, & Connectors



V-WS-CT-01 x1

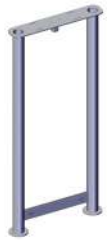

V-LG-05 x1

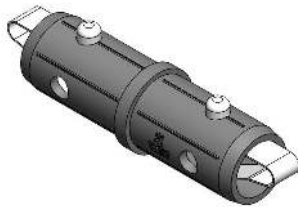

TC-30-S x1



IB2 x8

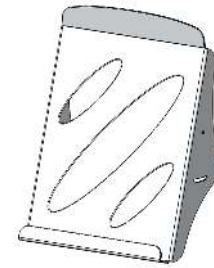

LN112 x3



LUM-LED2-ORL-B x2

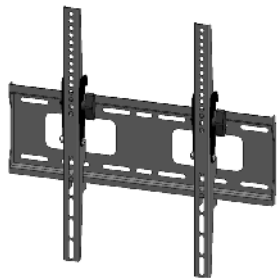

EXT-M-MB x1

Graphics



HP-02-A-G x1



HP-02-B-G x1



HP-02-C-G x1

# Exploded View

HP-K-02  
Section 1

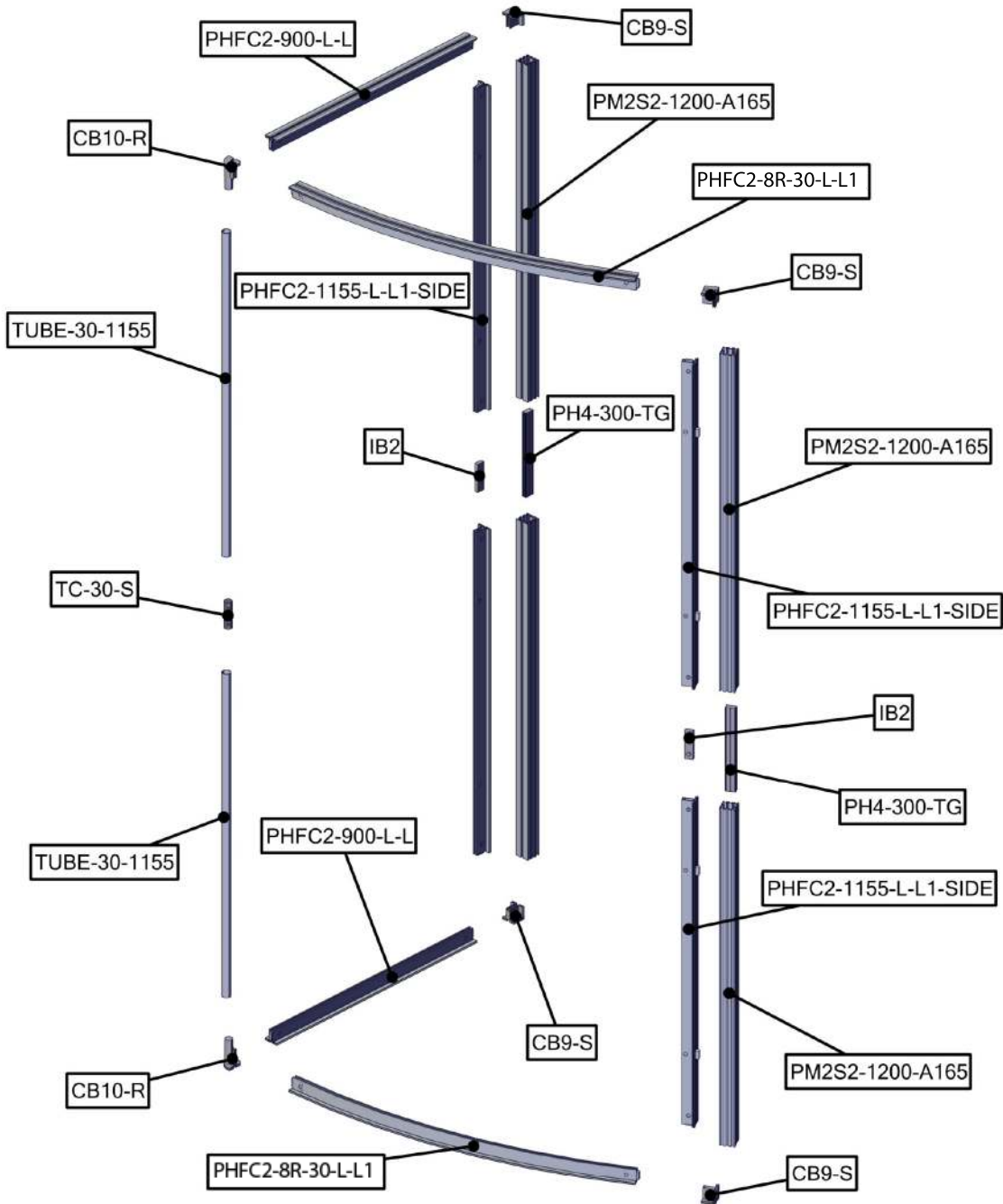

# Exploded View

HP-K-02  
Section 2

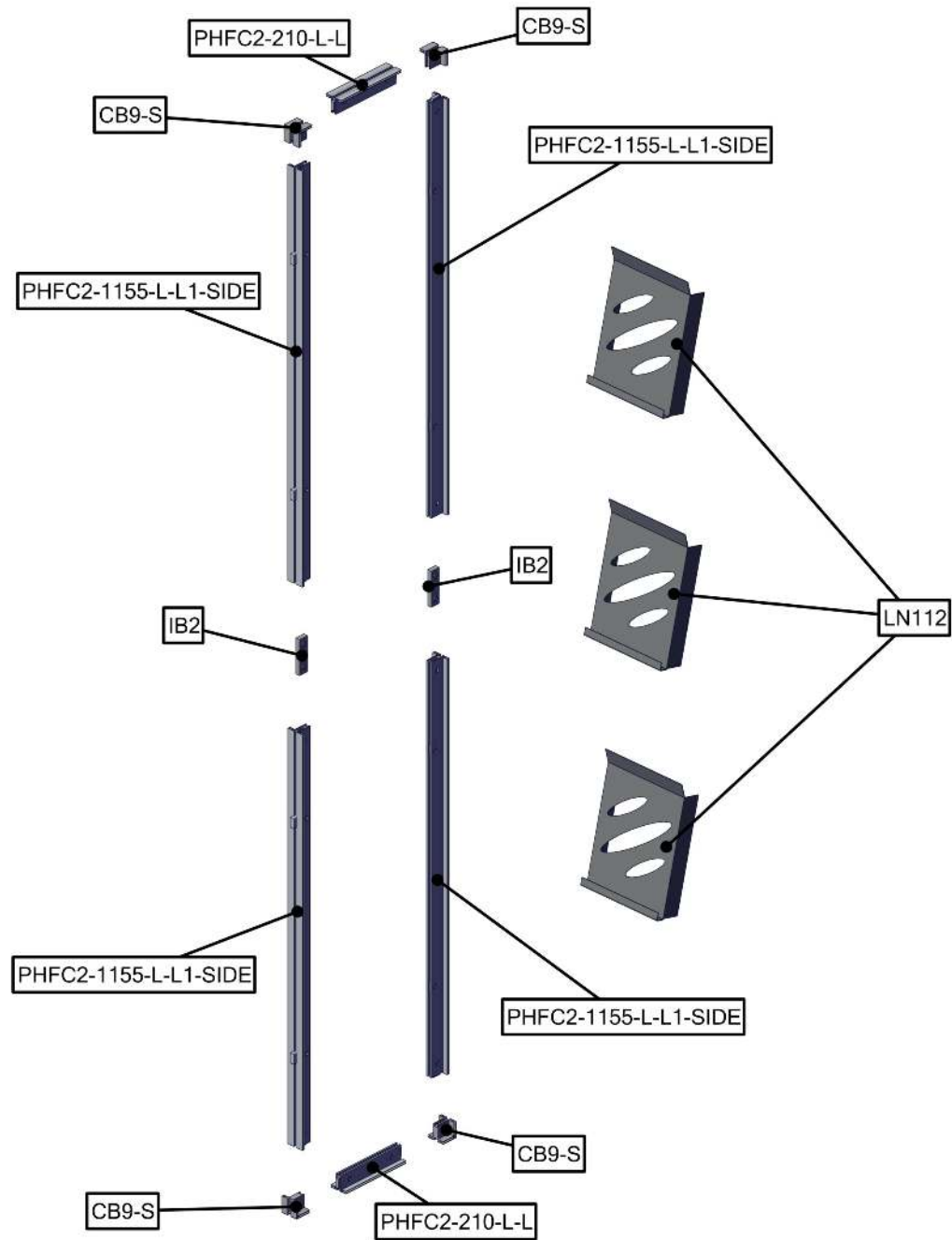

# Exploded View

HP-K-02  
Section 3

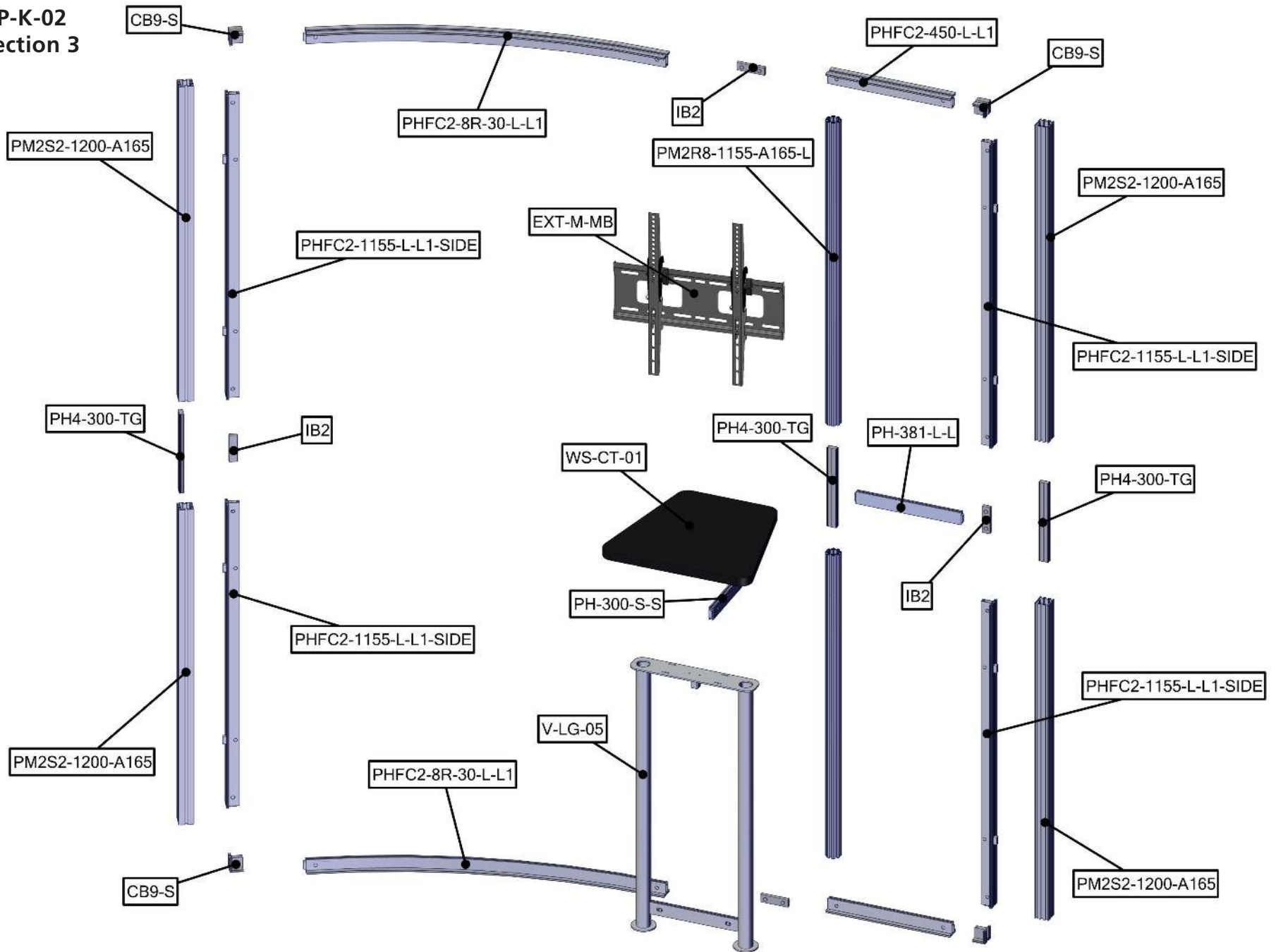

# Kit Assembly

## Step by Step

### Step 1.

Gather the components to build the first frame section. Use the Exploded View for part labels.

Reference Connection Method(s) 1, 2, 3, and 6 for more details.

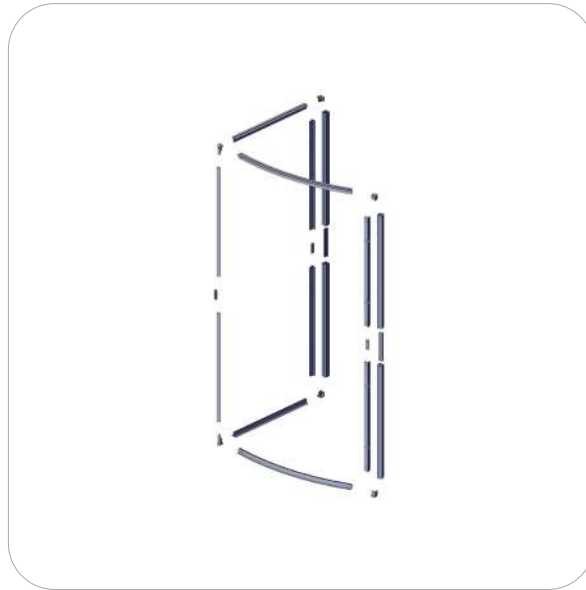

### Step 2.

Gather the components to build the third frame section. Use the Exploded View for part labels.

Reference Connection Method(s) 1, 2 and 3 for more details.

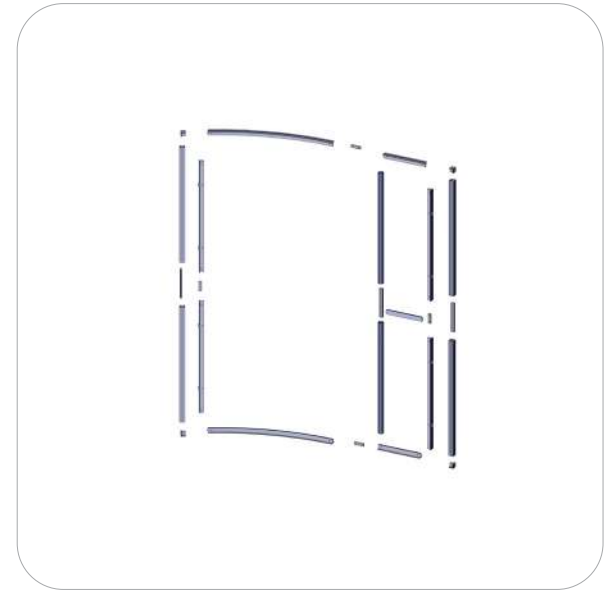

### Step 3.

Connect the first and third sections of the frame by building the second section and connecting the other sections to it. Use the Exploded View for part labels.

Reference Connection Method(s) 1, 2 and 3 for more details.

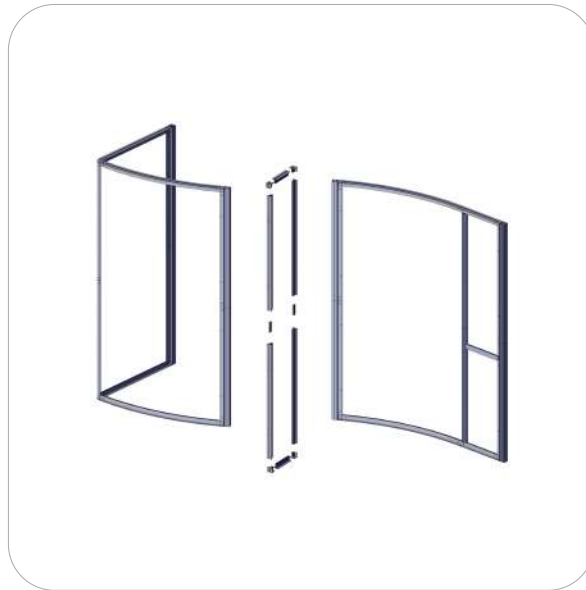

### Step 4.

Apply the graphics to the frame.

Reference Connection Method 5 for more details.

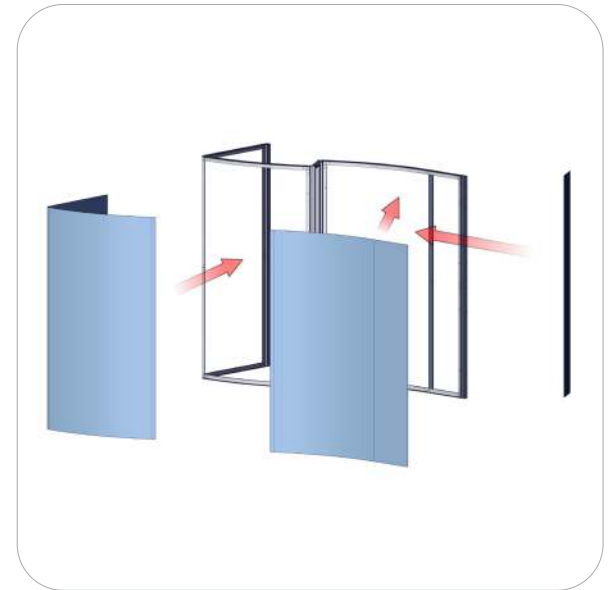

# Kit Assembly

## Step by Step

### Step 5.

Connect the tabletop to the frame.

Reference Connection Method 4 for more details.



### Step 6.

Attach the literature holders to the frame.

Reference Connection Method 7 for more details.

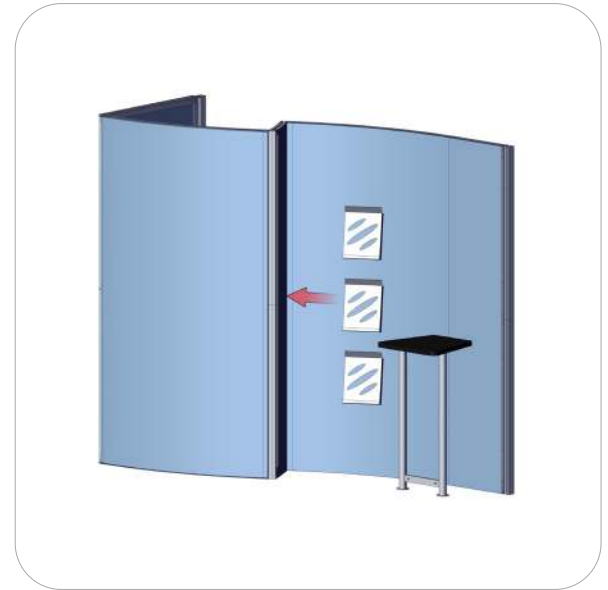

### Step 7.

Attach the monitor mount to the frame.

Reference the monitor mount supplemental sheet for more details.



### Step 8.

Clip on the lights to the top of the frame.

Setup is complete.





# Connection Methods

## Connection Method 1: IB2

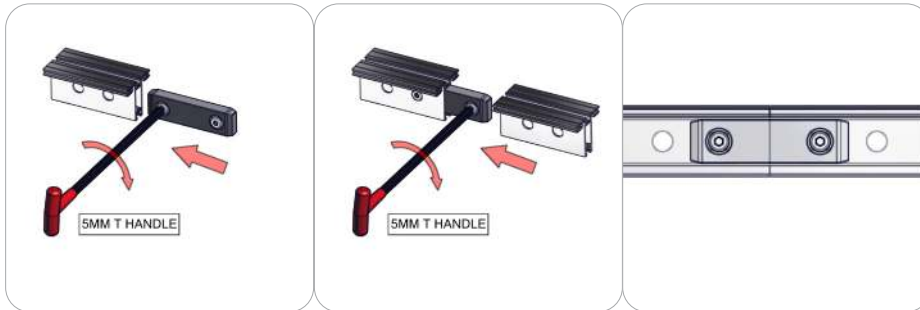

First, insert the in-line connector into the extrusion while holding in the lock button. Then, slide the next extrusion onto the same in-line connector again holding in the lock button. Finally, use the provided allen key to lock the in-line connector in place. Use the allen key tool to turn the lock buttons, make quarter turns and do not over tighten the lock buttons.

## Connection Method 2: P90R / PH-L



First, with the cam lock disengaged, place the cam lock teeth into the extrusion channel. Second, use the allen key tool to lock it in place. Make half turns clock-wise to engage the cam lock. Do not over tighten the lock buttons.

## Connection Method 3: CB9-R / CB9-S



First, make sure the cam lock button is unlocked. Second, insert the cam lock teeth in to corner bracket channel. Third, tighten the cam lock button. Use the allen key tool to turn the lock buttons, make quarter turns and do not over tighten the lock buttons. Repeat for opposite end.

## Connection Method 4: Counter Legs with thumb screw

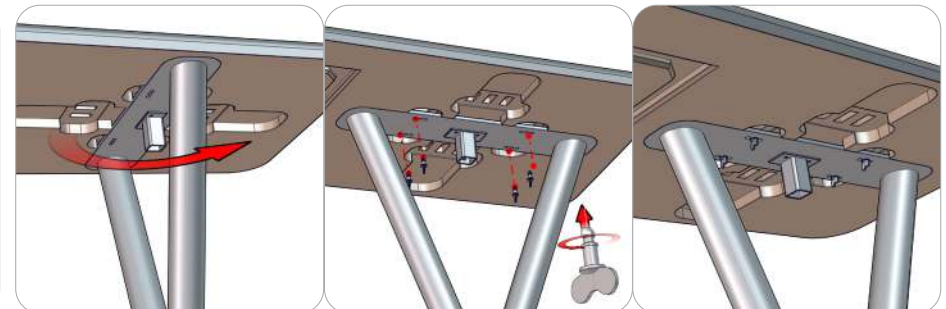

First, choose an orientation for the counter leg to be positioned on the under side of the counter top. With the counter leg in place, use the thumb screws to fasten the top plate of the leg onto the underside of the counter top. Do not over tighten.

# Connection Methods

## Connection Method 5: Graphic Application

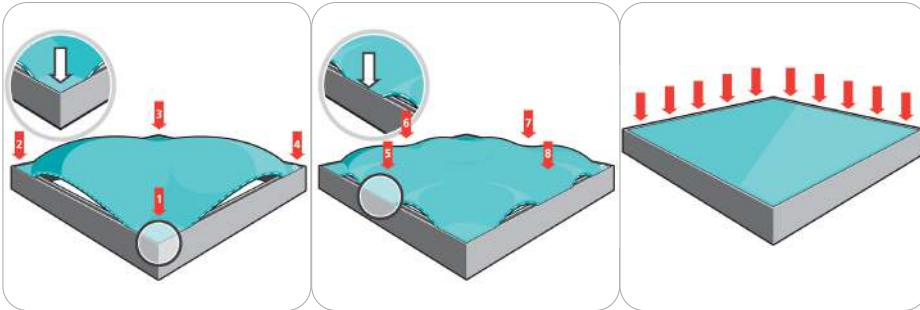

First, insert the silicone edge frame corners into the frame graphic channel (points 1 through 4).  
Second, insert the silicone edge frame sides into the frame graphic channel (points 5 through 8).  
Third, push the remaining silicone edge fabric into the frame graphic channel.  
Similar setup is recommended for the opaque liner.  
To remove these panels, simply pull the loop tag sewn near a corner.

## Connection Method 6: TC-30-S

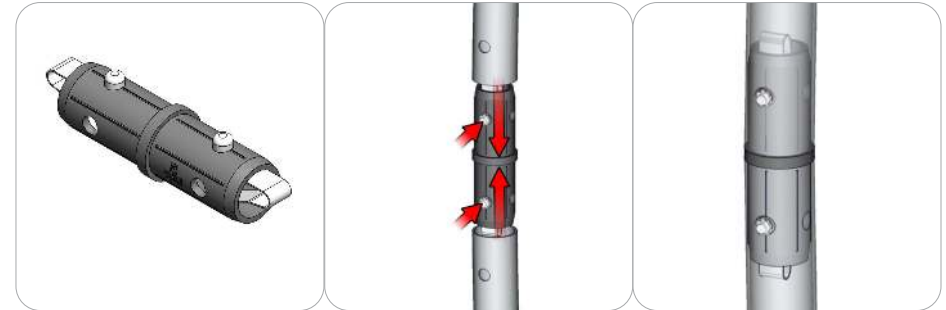

Take the plastic connector and make sure the snap buttons are in proper position for the frame tube holes. Simply press the snap button with your thumb and carefully slide the tube onto the connector. The snap button should pop through. Some twisting may be necessary to assure the snap button has popped all the way through the tube hole. Do not force the connection and be careful with the tube edges, they may be sharp.

## Connection Method 7: Literature Pockets LN112

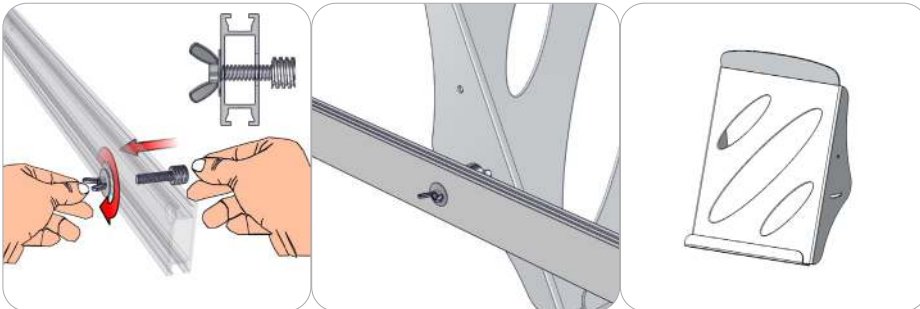

First, using your allen key tool for the installed cam locks, install the PH onto the frame extrusion channel. Second, find the hole on the center of the PH extrusion. Install the NT4 with wing nut onto the PH extrusion hole. Third, attach the stand off CKSO onto the NT4. Next, attach the LN112 onto the stand off with the CKSO cap.

# Monitor Bracket Instructions

## Extrusion Channel Applications



### EXT-SM-MB

Sizes: 23" - 42"

Max weight varies per application

**Assembled unit:**

9" w x 16" h x 1.4" d  
230mm (w) x 410mm (h) x 35mm (d)

**Shipping dimensions:**

14" l x 6" h x 4" d  
356mm (l) x 152mm (h) x 102mm (d)

**Approximate total shipping weight:**

6 lbs / 2.7 kgs

**VESA:**

75 x 75 - 200 x 200mm



### EXT-M-MB

Sizes: 32" - 55"

Max weight varies per application

**Assembled unit:**

16" w x 16" h x 1.4" d  
410mm (w) x 410mm (h) x 35mm (d)

**Shipping dimensions:**

24" l x 4" h x 4" d  
610mm (l) x 102mm (h) x 102mm (d)

**Approximate total shipping weight:**

7 lbs / 3.2 kgs

**VESA:**

100 x 100 - 400 x 400mm



### EXT-LG-MB

Sizes: 37" - 70"

Max weight varies per application

**Assembled unit:**

24" w x 16" h x 1.4" d  
610mm (w) x 410mm (h) x 35mm (d)

**Shipping dimensions:**

28" l x 6" h x 6" d  
711mm (l) x 152mm (h) x 152mm (d)

**Approximate total shipping weight:**

8 lbs. / 3.6 kgs

**VESA:**

100 x 100 - 600 x 400mm

### Included hardware:

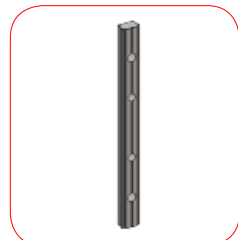

LN-100

x2



M5 x 10

LN-LCD-SCW

x2



1/4"-20 x 1"

BOLT-1

x2



1/4"-20

Flange Wingnut

x2

# EXTRUSION CONNECTION

## Channel Connection A

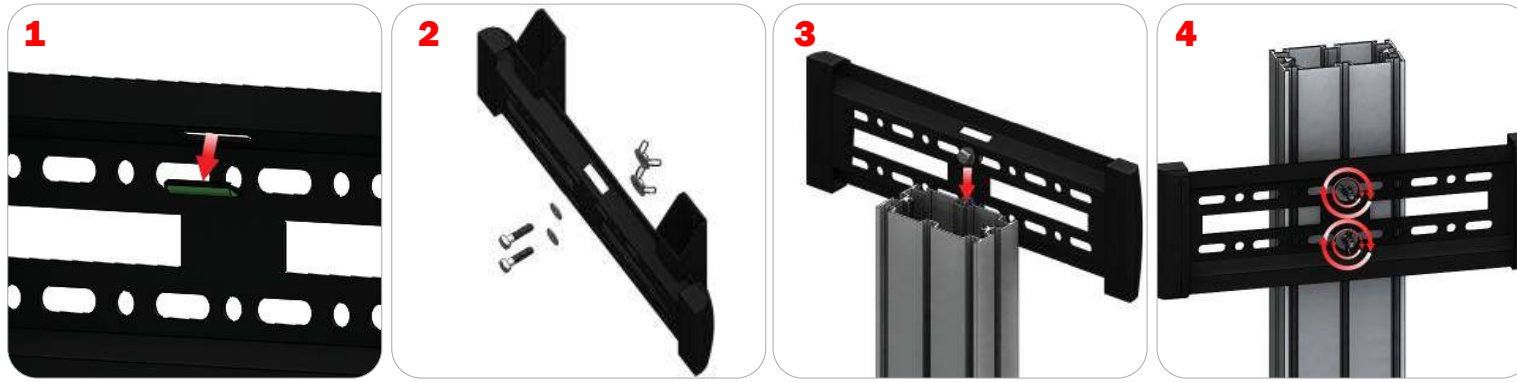

Locate all components needed to assemble the monitor mount with the channel connection A method. You will need (1) monitor bracket, (2) square head bolts, (2) washers, and (2) wingnuts.

**Step 1:** Apply pressure to the rear side of the leveling gauge clipped into the monitor mount to remove it. **Step 2:** Insert the provided bolts through the washers and center top and bottom holes of the monitor mount. Loosely thread your wingnuts onto the end of the bolts. **Step 3:** Slide the bolt heads down the extrusion channel.

**Step 4:** Tighten your wingnuts to lock the monitor bracket in place. **Step 5:** Reference the included manufacturer monitor mount instructions for fastening your monitor to the bracket.

## Channel Connection B



Locate all components needed to assemble the monitor mount with the channel connection B method. You will need (1) monitor bracket, (2) LN-LCD-SCW, (2) LN-100, and (2) washers.

**Step 1:** Apply pressure to the rear side of the leveling gauge clipped into the monitor mount to remove it. **Step 2:** Loosely thread the LN-LCD-SCW screws through the washers, the center top and bottom holes of the monitor bracket, and through the LN-50 holes. **Step 3:** Slide the LN-100s down the extrusion channel. **Step 4:** Tighten your LN-LCD-SCW to lock the monitor bracket in place.

**Step 5:** Reference the included manufacturer monitor mount instructions for fastening your monitor to the bracket.

## TRI-30MM Channel Tube Connection



Locate all components needed to assemble the monitor mount with the TRI-30MM Channel Tube Connection method. You will need (1) monitor bracket, (2) Square Bolts, and (2) Wingnuts.

**Step 1:** Slip the head of the square bolts into the extrusion channel of the tube. **Step 2:** Apply your monitor bracket to the protruding square bolts. **Step 3:** Lock your monitor bracket to the square bolts using the provided wingnuts. **Step 4:** Reference the included manufacturer monitor mount instructions for fastening your monitor to the bracket.