

# Zoom 20' Standard Popup Tent

## ZM-TNT-STD-3MX6M

The Zoom Tent is great for outdoor fairs, exhibitions, sporting events and arenas, concerts, festivals and more. Strong, solid, stable, wind-resistant & durable. Graphics are long-lasting and can endure exposure to outdoor elements. Polyester canopies and sidewalls are water resistant and UV-resistant, providing the ultimate protection from the sun. Coverage area shades up to five people comfortably.



## features and benefits:

- Various kits available
- **Hardware kits** include frame, stakes, guy ropes & rolling carry bag
- **Canopy kits** include a canopy with a choice of either standard color or custom print and the hardware kit items
- **Half wall kits** include 2 panels with a choice of either standard color or custom print, 2 poles and 3 brackets
- **Half wall hardware only kits** include 2 poles and 3 brackets
- **Full wall or half wall kits** include a canopy with a choice of either standard color or custom print, sold separately
- Folds compactly into portable packing with rolling carry bag
- One year hardware warranty against manufacture defects
- Six months graphics limited warranty
- Usage in adverse weather voids warranties
- Tent legs are anodized silver and hexagonal shaped
- The OCE expandable shipping case is an optional upgrade

## dimensions:

### Hardware

### Assembled unit:

234.32" w x 135.43" h x 118.39" d  
5952mm(w) x 3440mm(h) x 3532mm(d)

Approximate weight: (as shown to the left)  
117 lb / 53 kg

### Graphic

Refer to related graphic template for more information.

Visit:

[www.exhibitors-handbook.com/graphic-templates](http://www.exhibitors-handbook.com/graphic-templates)

### Shipping

Packs in a wheeled bag and ships in a box.

### ZM-TNT-STD-3MX6M-WHEEL-BG:

62" l x 10" h x 10" d  
1575mm(l) x 254mm(h) x 254mm(d)

### Box: 66" l x 19" h x 12" d

1660mm(l) x 483mm(h) x 305mm(d)

Approximate weight: (as shown to the left)

123 lb / 56 kg

## additional information:

### Graphic material:

Outdoor Canvas, there will be a solid white or black cording to hide the seam where the individual graphic panels come together.

Color material: 420D polyester PU coating  
Color Options: white, black, blue, gray, red  
Pantone® provided below is closest match  
Canopy, Full wall & Half wall Stock Colors:

Red - 186C

Blue - 286C

Grey - 429C

White

Black

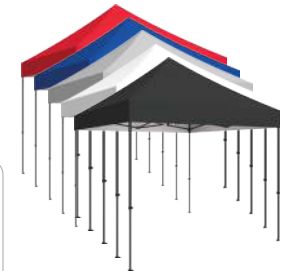
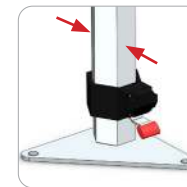

Leg width: 40mm

Opens to base size of 20' w x 10' d

Optional set of 4 weight bases, 22 lb. ea.

Code: ZM-TNT-STEEL-BASE-K

Additional set of 4 pegs and 3.5 meter guy ropes. Code: ZM-TNT-PEG-KIT

Caution, do not pack the base weights in the bag or case.

**2 person assembly recommended:**



We are continually improving and modifying our product range and reserve the right to vary the specifications without prior notice. All dimensions and weights quoted are approximate and we accept no responsibility for variance. E&OE. See Graphic Templates for graphic bleed specifications.

# Codes and Shipping Information

Code	Description	Shipping Dimension	Approximate Shipping Weight
ZM-TNT-STD-3MX6M-FRM-HEX	3M x 6M canopy frame with HEX legs and ZM-TNT-PEG-KIT set of 4 pegs (no canopy) in a black roller bag	Box: 66"l x 19"h x 12"d	77 lb / 35 kg
ZM-TNT-STD-3MX6M-CAN-BLK	BLACK canopy top 420D Polyester PU coating for 3mx6m canopy frames	Box: 24"l x 14"h x 8"d	15 lb / 7 kg
ZM-TNT-STD-3MX6M-CAN-BLU	BLUE canopy top 420D Polyester PU coating for 3mx6m canopy frames	Box: 24"l x 14"h x 8"d	15 lb / 7 kg
ZM-TNT-STD-3MX6M-CAN-G	CUSTOM PRINTED canopy top 420D Polyester PU coating for 3mx6m canopy frames	Box: 24"l x 14"h x 8"d	15 lb / 7 kg
ZM-TNT-STD-3MX6M-CAN-GRY	GRAY canopy top 420D Polyester PU coating for 3mx6m canopy frames	Box: 24"l x 14"h x 8"d	15 lb / 7 kg
ZM-TNT-STD-3MX6M-CAN-RED	RED canopy top 420D Polyester PU coating for 3mx6m canopy frames	Box: 24"l x 14"h x 8"d	15 lb / 7 kg
ZM-TNT-STD-3MX6M-CAN-WHT	WHITE canopy top 420D Polyester PU coating for 3mx6m canopy frames	Box: 24"l x 14"h x 8"d	15 lb / 7 kg
ZM-TNT-3MX3M-HLF-WLL-BLK	Tent half wall, 3 meter x 0.75 meter, black on both sides 420D with UV coating	Box: 24"l x 14"h x 4"d	2 lb / 1 kg
ZM-TNT-3MX3M-HLF-WLL-BLU	Tent half wall, 3 meter x 0.75 meter, blue on both sides 420D with UV coating	Box: 24"l x 14"h x 4"d	2 lb / 1 kg
ZM-TNT-3MX3M-HLF-WLL-G	Tent half wall, 3 meter x 0.75 meter, CUSTOM PRINTED on one side 420D with UV coating	Box: 24"l x 14"h x 4"d	2 lb / 1 kg
ZM-TNT-3MX3M-HLF-WLL-GDBL	Tent half wall, 3 meter x 0.75 meter, CUSTOM PRINTED on both sides 420D with UV coating	Box: 24"l x 14"h x 4"d	2 lb / 1 kg
ZM-TNT-3MX3M-HLF-WLL-GRY	Tent half wall, 3 meter x 0.75 meter, gray on both sides 420D with UV coating	Box: 24"l x 14"h x 4"d	2 lb / 1 kg
ZM-TNT-3MX3M-HLF-WLL-RED	Tent half wall, 3 meter x 0.75 meter, red on both sides 420D with UV coating	Box: 24"l x 14"h x 4"d	2 lb / 1 kg
ZM-TNT-3MX3M-HLF-WLL-WHT	Tent half wall, 3 meter x 0.75 meter, white on both sides 420D with UV coating	Box: 24"l x 14"h x 4"d	2 lb / 1 kg
ZM-TNT-STD-3MX6M-HLFWLL-KIT	3MX6M Tent Half wall Hardware kit, includes two half wall bars and three half wall mounting brackets	Box 1: 62"l x 5"h x 5"d	8 lb / 3 kg
ZM-TNT-STEEL-BASE-K	Set of 4 black steel weights for tent frame legs, 2 per box, each base weight is 22 lb / 10 kg	Box 1: 12"l x 11"h x 3"d, 44 lb / 20 kg Box 2: 12"l x 11"h x 3"d, 44 lb / 20 kg	88 lb / 40 kg

# Codes and Shipping Information Cont'd

Code	Description	Shipping Dimension	Approximate Shipping Weight
ZM-TNT-STD-3MX6M-FLL-WLL-BLK	Set of 2 BLACK full tent wall, 3meter x 2.15 meter, 420D with UV coating for 3M x 6M HEX leg canopy frame	Box: 24"l x 14"h x 4"d	10 lb / 5 kg
ZM-TNT-STD-3MX6M-FLL-WLL-BLU	Set of 2 BLUE full tent wall, 3meter x 2.15 meter, 420D with UV coating for 3M x 6M HEX leg canopy frame	Box: 24"l x 14"h x 4"d	10 lb / 5 kg
ZM-TNT-STD-3MX6M-FLL-WLL-G	Set of 2 CUSTOM PRINTED full tent wall, 3meter x 2.15 meter, 420D with UV coating for 3M x 6M HEX leg canopy frame	Box: 24"l x 14"h x 4"d	10 lb / 5 kg
ZM-TNT-STD-3MX6M-FLL-WLL-GDBL	Set of 2 CUSTOM PRINTED full tent wall, 3meter x 2.15 meter, 420D with UV coating for 3M x 6M HEX leg canopy frame	Box: 24"l x 14"h x 4"d	10 lb / 5 kg
ZM-TNT-STD-3MX6M-FLL-WLL-GRY	Set of 2 BLACK full tent wall, 3meter x 2.15 meter, 420D with UV coating for 3M x 6M HEX leg canopy frame	Box: 24"l x 14"h x 4"d	10 lb / 5 kg
ZM-TNT-STD-3MX6M-FLL-WLL-RED	Set of 2 BLACK full tent wall, 3meter x 2.15 meter, 420D with UV coating for 3M x 6M HEX leg canopy frame	Box: 24"l x 14"h x 4"d	10 lb / 5 kg
ZM-TNT-STD-3MX6M-FLL-WLL-WHT	Set of 2 BLACK full tent wall, 3meter x 2.15 meter, 420D with UV coating for 3M x 6M HEX leg canopy frame	Box: 24"l x 14"h x 4"d	10 lb / 5 kg
ZM-TNT-STD-3MX6M-HEX-BLK	3M x 6M canopy frame with HEX legs, 4 stakes, 4 guide lines in a black roller bag with BLACK canopy top	Box 1: 66"l x 19"h x 12"d Box 2: 24"l x 14"h x 8"d	92 lb / 42 kg
ZM-TNT-STD-3MX6M-HEX-BLU	3M x 6M canopy frame with HEX legs, 4 stakes, 4 guide lines in a black roller bag with BLUE canopy top	Box 1: 66"l x 19"h x 12"d Box 2: 24"l x 14"h x 8"d	92 lb / 42 kg
ZM-TNT-STD-3MX6M-HEX-G	3M x 6M canopy frame with HEX legs, 4 stakes, 4 guide lines in a black roller bag with CUSTOM PRINTED canopy top	Box 1: 66"l x 19"h x 12"d Box 2: 24"l x 14"h x 8"d	92 lb / 42 kg
ZM-TNT-STD-3MX6M-HEX-GRY	3M x 6M canopy frame with HEX legs, 4 stakes, 4 guide lines in a black roller bag with GRAY canopy top	Box 1: 66"l x 19"h x 12"d Box 2: 24"l x 14"h x 8"d	92 lb / 42 kg
ZM-TNT-STD-3MX6M-HEX-RED	3M x 6M canopy frame with HEX legs, 4 stakes, 4 guide lines in a black roller bag with RED canopy top	Box 1: 66"l x 19"h x 12"d Box 2: 24"l x 14"h x 8"d	92 lb / 42 kg
ZM-TNT-STD-3MX6M-HEX-WHT	3M x 6M canopy frame with HEX legs, 4 stakes, 4 guide lines in a black roller bag with WHITE canopy top	Box 1: 66"l x 19"h x 12"d Box 2: 24"l x 14"h x 8"d	92 lb / 42 kg
ZM-TNT-STD-3MX6M-HLF-K-BLK	BLACK half wall kit, includes necessary hardware & side panels, 3M x 0.75M Polyester 420D with UV coating for 3MX6M frame	Box 1: 62"l x 5"h x 5"d Box 2: 24"l x 14"h x 4"d	13 lb / 7 kg
ZM-TNT-STD-3MX6M-HLF-K-BLU	BLUE half wall kit, includes necessary hardware & side panels, 3M x 0.75M Polyester 420D with UV coating for 3MX6M frame	Box 1: 62"l x 5"h x 5"d Box 2: 24"l x 14"h x 4"d	13 lb / 7 kg
ZM-TNT-STD-3MX6M-HLF-K-G	CUSTOM PRINTED half wall kit, includes necessary hardware & side panels, 3M x 0.75M Polyester 420D with UV coating for 3MX6M frame	Box 1: 62"l x 5"h x 5"d Box 2: 24"l x 14"h x 4"d	13 lb / 7 kg
ZM-TNT-STD-3MX6M-HLF-K-GRY	GRAY half wall kit, includes necessary hardware & side panels, 3M x 0.75M Polyester 420D with UV coating for 3MX6M frame	Box 1: 62"l x 5"h x 5"d Box 2: 24"l x 14"h x 4"d	13 lb / 7 kg
ZM-TNT-STD-3MX6M-HLF-K-RED	RED half wall kit, includes necessary hardware & side panels, 3M x 0.75M Polyester 420D with UV coating for 3MX6M frame	Box 1: 62"l x 5"h x 5"d Box 2: 24"l x 14"h x 4"d	13 lb / 7 kg
ZM-TNT-STD-3MX6M-HLF-K-WHT	WHITE half wall kit, includes necessary hardware & side panels, 3M x 0.75M Polyester 420D with UV coating for 3MX6M frame	Box 1: 62"l x 5"h x 5"d Box 2: 24"l x 14"h x 4"d	13 lb / 7 kg

# Connection Methods

## Connection Method 1: Engage/Disengage Slide Lock



The frame will have four slide locks, one for each corner. When the tent scissor frame is fully extended; make sure the prong of the slide lock snaps into the tube locator hole. Press the lever on the slide lock to disengage the prong from the tube allowing to slide the lock up or down during assembly.

## Connection Method 2: Extend Tent Poles

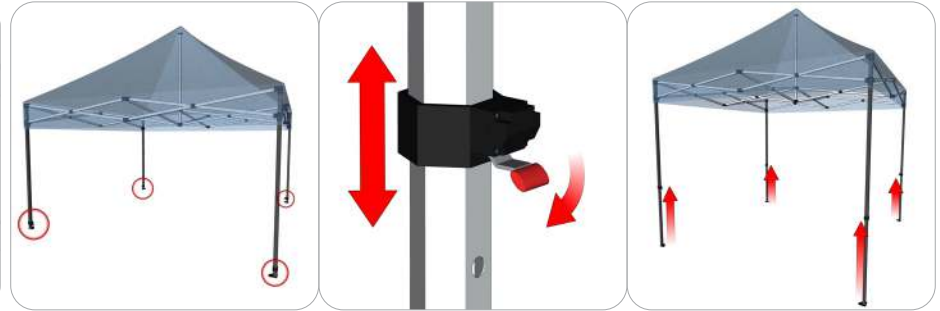

At two adjacent corners of the tent, slide the inner legs up until the snap button locks into the hole of the outer leg. Repeat with the remaining two legs. Minimum of two people recommended.

## Connection Method 3: Raise Canopy Tension

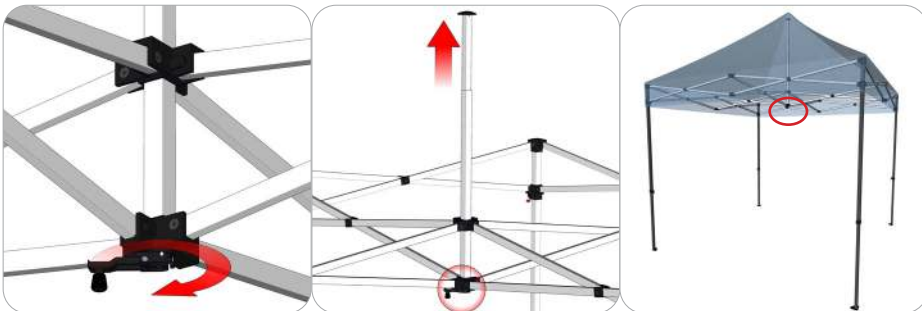

The frame will have one canopy tensioner at the center of the underside. Carefully turn the lever clockwise to create tension on the canopy. This will raise the canopy and eliminate wrinkles.

## Connection Method 4: Release Canopy Tension

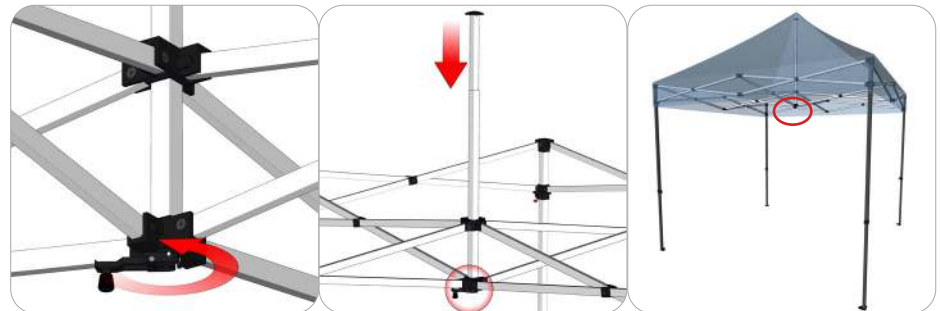

The frame will have one canopy tensioner at the center of the underside. Carefully turn the handle counter-clockwise to eliminate tension on the canopy. This will lower the canopy and simplify disassembly.

# Kit Assembly

## Step by Step

### Step 1.

Remove the frame out of the carry bag. Stand the frame on its feet. Clear the area for expanding the frame.



### Step 2.

Carefully expand the frame to approximately 1/3 open. Use caution when handling and interacting with this product, it may contain sharp and pinching components.



### Step 3.

With the frame at approximately 1/3 open, spread and align the canopy over the top of the frame and Velcro attach to the 4 corners.



### Step 4.

Lift the 4 side header flaps of the canopy and Velcro attach the middle points to the scissor frame. Once these are done, replace the canopy header flaps.



# Kit Assembly

## Step by Step

### Step 5.

Expand the frame and lock in the 4 upper sliding hubs at each corner. You can unlock the sliding hub by pressing and holding the red lever to disengage the internal prong.

Refer to Connection Method 1 for more details.



### Step 6.

Expand the legs to one side of the tent until the sliding hubs snap lock into the first hole. Then lift the opposite side to level out. You can unlock the sliding hub by pressing and holding the red lever to disengage the internal prong.

Refer to Connection Method 2 for more details.

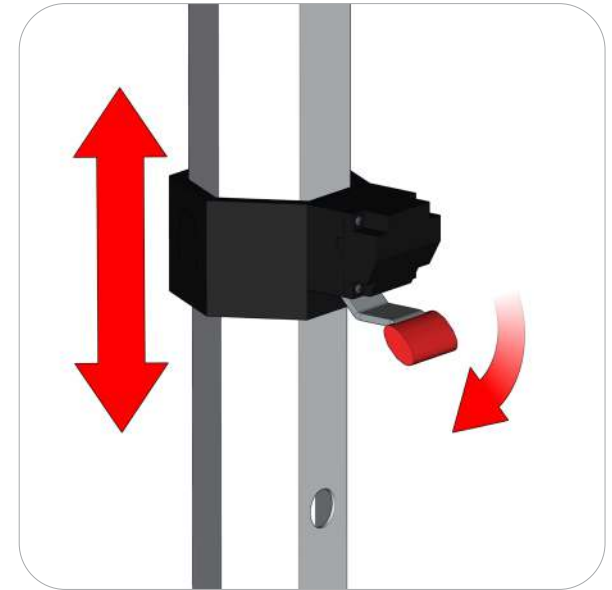

### Step 7.

With the frame leveled at the first hole of each leg, continue to move the sliding hubs up to the 3rd hole. You can unlock the sliding hub by pressing and holding the red lever to disengage the internal prong.

Refer to Connection Method 2 for more details.

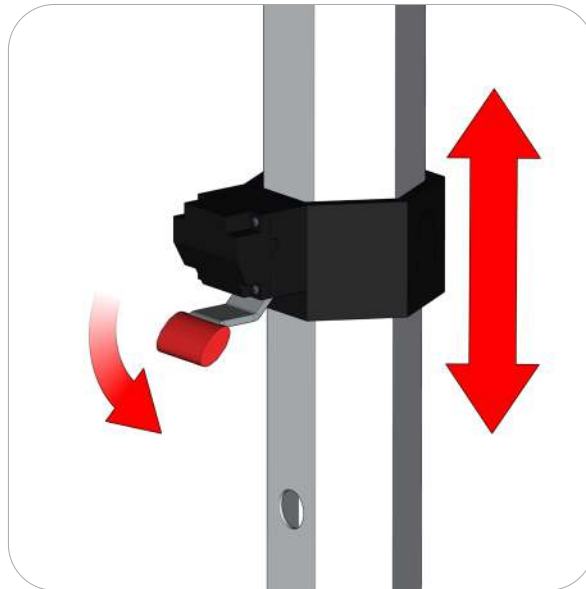

### Step 8.

The frame will have one canopy tensioner at the center of the underside. Carefully turn the lever clockwise to create tension on the canopy and eliminate wrinkles.

Refer to Connection Method(s) 3 and 4 for more details.

Canopy kit is complete.

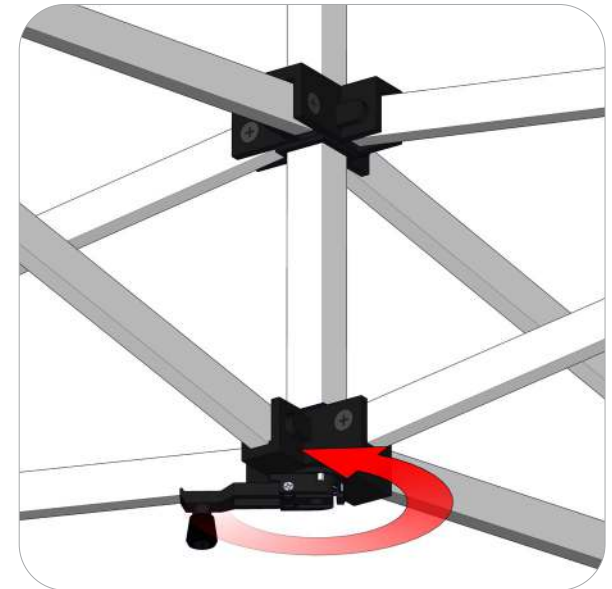

# Kit Assembly

## Step by Step

### Step 9.

Attach the full wall panels to the canopy top. Start the Velcro attachment on the inside of the canopy, top left corner.



### Step 10.

Secure the full wall panels to the frame legs with the Velcro tabs.

Full wall application is complete.



### Step 11.

For the half wall setup example, the attachment will be shown on this side of the frame back wall.

The half wall can be attached on any side without a back wall.



### Step 12.

Take the half wall telescoping pole and run it through the half wall pocket.



# Kit Assembly

## Step by Step

### Step 13.

Attach the center half wall bracket to the center frame leg.

For this example, attachment to this side of the frame is shown.



### Step 14.

Attach the end half wall brackets to the corner frame legs.

For this example, attachment to this side of the frame is shown.



### Step 15.

Velcro attach the half wall panels to the frame legs.



### Step 16.

Apply the optional base weights to the frame legs and use the guy wires and pegs to hold down your tent securely when outdoors. Caution, do not pack the base weights in the bag or case.

Setup is complete.



Tent bases sold separately.





# Zoom Popup Tent Essentials

## Care and Maintenance

1. Avoid use during heavy downpours and strong winds. Water may collect on canopy tops in heavy rain. Water must be pushed off the top or its weight may collapse the canopy.
2. This is a sewn product. Water may leak through needle holes in fabric during constant or heavy rain.
3. Always pack your canopy top dry to prevent mildew.
4. Remove your canopy top from the frame before storing or transporting.
5. The canopy should always be anchored. Spikes are provided for anchoring on turf. We recommend using the Base Weights for anchoring on solid surfaces.
6. Washing instruction. Place the canopy top on the frame at the lowest position and spot clean with mild detergent and a soft brush for soiled spots. Allow the top to dry completely before storing.
7. The frame will operate and look better if the bolts are tightened frequently. Use a Philips screwdriver for most fasteners. The tool is not included.

## Canopy Top Folding Instructions

**Caution:** Please use care when folding combination light and dark colored tops. Fabric dyes have a tendency to migrate from dark shades to lighter shades if the coated sides are in contact when folded and stored.

**Step 1.** Fold all four corners together and lay flat. This is the most important step in correctly folding color combination tops. Keep the coated side of the same color together to prevent color transfer.

**Step 2.** Take the four corners and fold them to the opposite side.

**Step 3.** Fold the tip of the top down to the bottom edge.

**Step 4.** Fold in half lengthwise bringing the top to the bottom edge.

**Step 5.** Fold into thirds and place in bag.

