

# Vector Frame Kit 08

## VF-K-08A

Stand apart from the competition with a clean, sophisticated 10' x 10' or 10' x 20' Vector Frame™ exhibit kit. These graphic mural kits feature square-corner 50mm extrusion frames and push-fit fabric graphics that cover the entire frame. Vector Frame Essential kits are easy to assemble and disassemble.



## features and benefits:

- 50mm silver extrusion frame
- Single-sided fabric graphics
- Easy step-by-step instructions
- Kit includes: one frame, five fabric graphics, four 120 watt floodlights, and one wheeled molded case
- Lifetime hardware warranty against manufacturer defects

## dimensions:

### Hardware

### Graphic

Assembled Unit:  
190.24"w x 94.5"h x 54"d  
4832mm(w) x 2400mm(h) x 1372mm(d)

Refer to related graphic template for more information.

Approximate weight:  
104 lbs / 48 kg

Visit:  
<https://www.theexhibitorshandbook.com/download-graphic-templates>

### Shipping

## additional information:

Packing case(s):  
1 OCE

Graphic material:  
Dye-sublimation SEG push-fit fabric

Shipping dimensions:  
OCE: Expandable case length (l) may vary  
40" - 66"l x 18"h x 18"d  
1016mm-1677mm(l) x 458mm(h) x 458mm(d)

Lights Included:  
Lumina 200

Approximate total shipping weight:  
131 lbs / 60 kg



This product may include the following materials for recycle:  
aluminum, select wood, fabric, cardboard, paper, steel, and plastics.

2 person assembly recommended:



We are continually improving and modifying our product range and reserve the right to vary the specifications without prior notice. All dimensions and weights quoted are approximate and we accept no responsibility for variance. E&OE. See Graphic Templates for graphic bleed specifications.

\*Not to scale

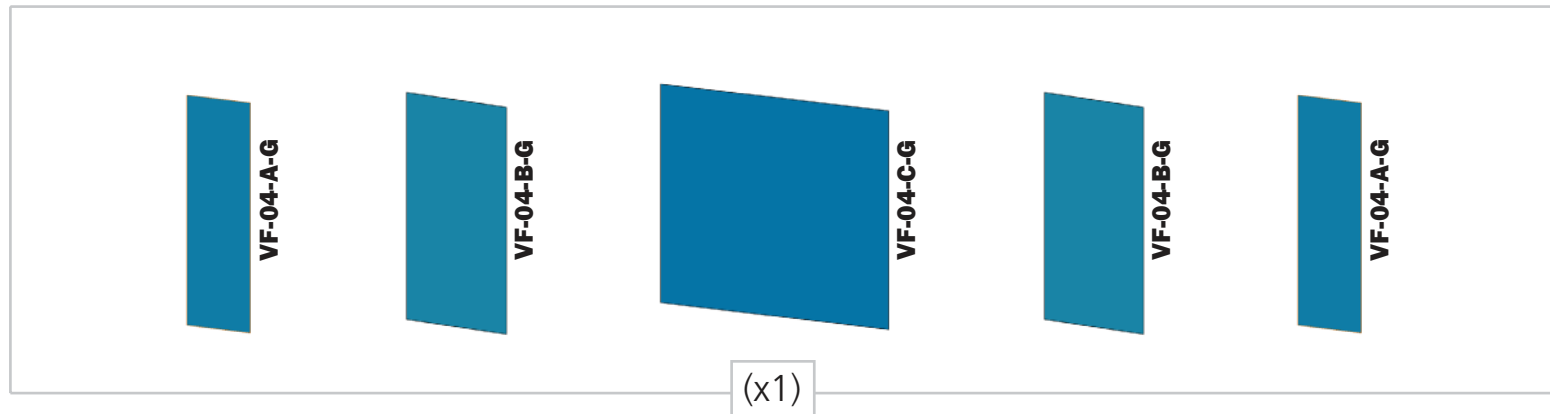
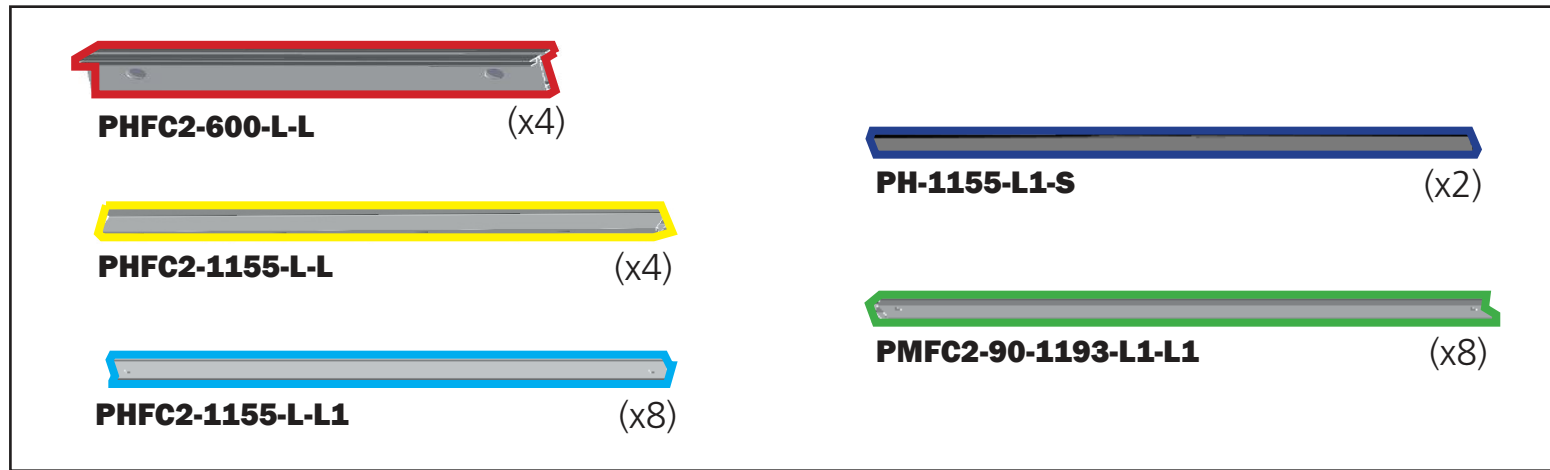

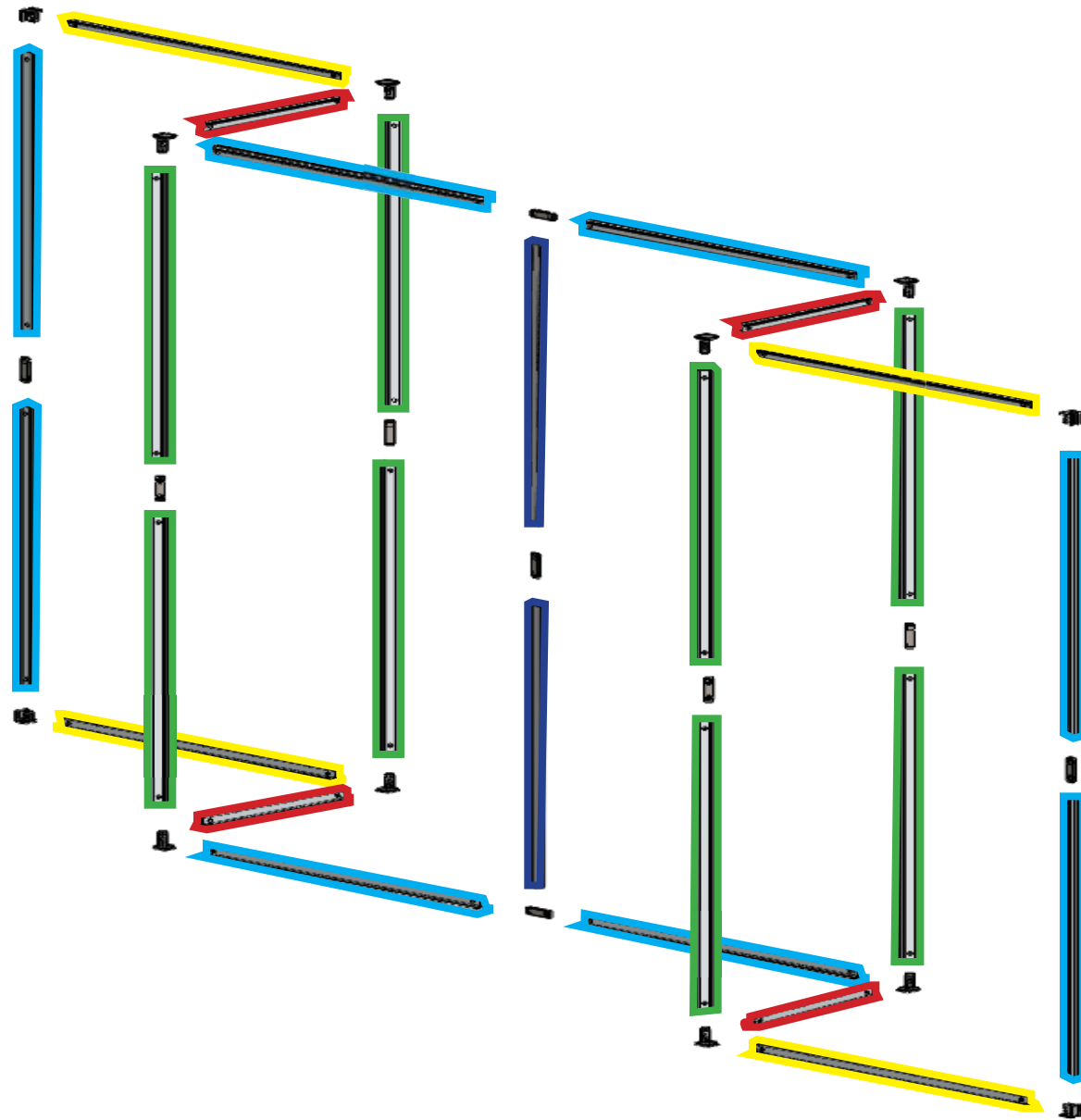

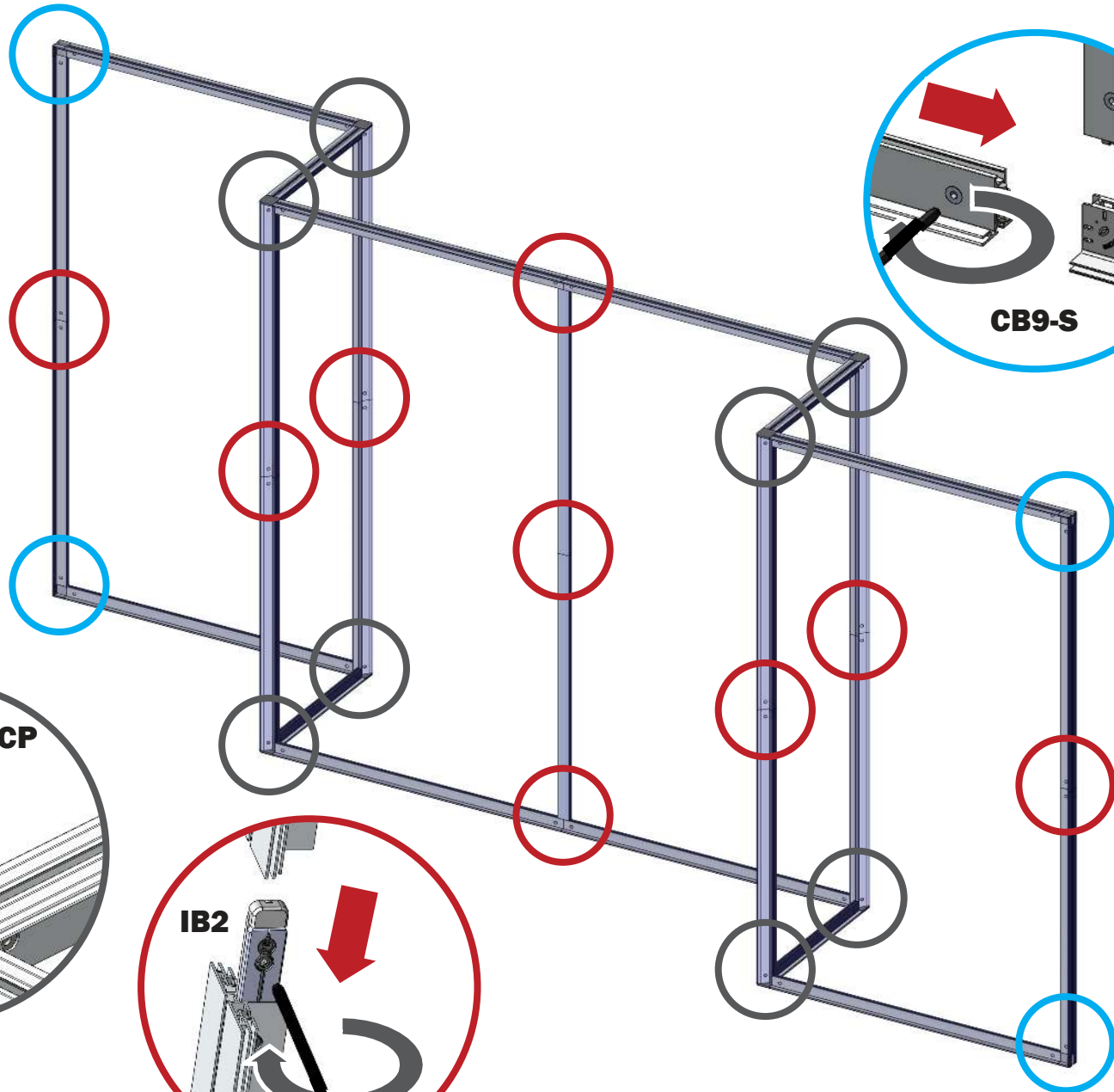
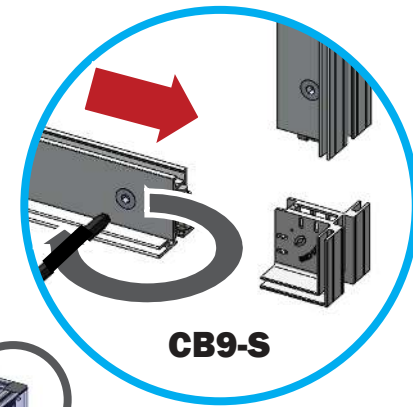
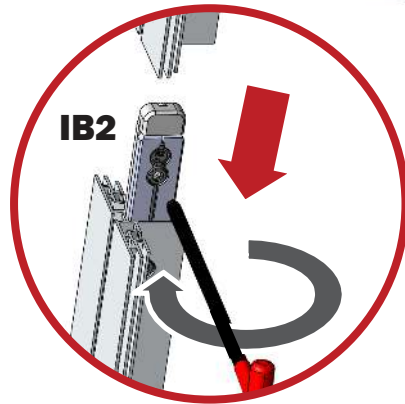
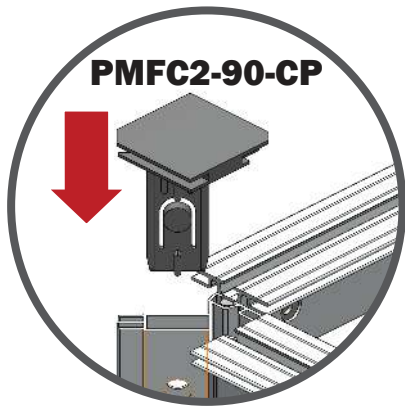

Fit graphic into corners, then "tap" into rest of frame channel.  
"Sliding down" graphic is not recommended for best installation.

Repeat for backer and for all other frames.

